



SECTION A. Table of Contents

Section A. Facility/Source Identification

Table of Contents
Site Inventory List

Section B. General Title V Requirements

- #001 Definitions
- #002 Prohibition of Air Pollution
- #003 Property Rights
- #004 Permit Expiration
- #005 Permit Renewal
- #006 Transfer of Ownership or Operational Control
- #007 Inspection and Entry
- #008 Compliance Requirements
- #009 Need to Halt or Reduce Activity Not a Defense
- #010 Duty to Provide Information
- #011 Reopening and Revising the Title V Permit for Cause
- #012 Reopening a Title V Permit for Cause by EPA
- #013 Operating Permit Application Review by the EPA
- #014 Significant Operating Permit Modifications
- #015 Minor Operating Permit Modifications
- #016 Administrative Operating Permit Amendments
- #017 Severability Clause
- #018 Fee Payment
- #019 Authorization for De Minimis Emission Increases
- #020 Reactivation of Sources
- #021 Circumvention
- #022 Submissions
- #023 Sampling, Testing and Monitoring Procedures
- #024 Compliance Certification
- #025 Recordkeeping Requirements
- #026 Reporting Requirements
- #027 Operational Flexibility
- #028 Risk Management
- #029 Approved Economic Incentives and Emission Trading Programs
- #030 Permit Shield
- #031 Reporting
- #032 Report Format

Section C. Site Level Title V Requirements

- C-I: Restrictions
- C-II: Testing Requirements
- C-III: Monitoring Requirements
- C-IV: Recordkeeping Requirements
- C-V: Reporting Requirements
- C-VI: Work Practice Standards
- C-VII: Additional Requirements
- C-VIII: Compliance Certification
- C-IX: Compliance Schedule

Section D. Source Level Title V Requirements

- D-I: Restrictions
- D-II: Testing Requirements
- D-III: Monitoring Requirements
- D-IV: Recordkeeping Requirements
- D-V: Reporting Requirements



SECTION A. Table of Contents

D-VI: Work Practice Standards
D-VII: Additional Requirements

Note: These same sub-sections are repeated for each source!

Section E. Source Group Restrictions

E-I: Restrictions
E-II: Testing Requirements
E-III: Monitoring Requirements
E-IV: Recordkeeping Requirements
E-V: Reporting Requirements
E-VI: Work Practice Standards
E-VII: Additional Requirements

Section F. Alternative Operating Scenario(s)

F-I: Restrictions
F-II: Testing Requirements
F-III: Monitoring Requirements
F-IV: Recordkeeping Requirements
F-V: Reporting Requirements
F-VI: Work Practice Standards
F-VII: Additional Requirements

Section G. Emission Restriction Summary

Section H. Miscellaneous

**SECTION A. Site Inventory List**

Source ID	Source Name	Capacity/Throughput		Fuel/Material
031	AREA HEATERS	41.000	Gal/HR	PROPANE GAS
		36.000	Gal/HR	OIL NO. 2
035	AIR MAKEUP UNITS 1 THRU 8	313.980	Gal/HR	Propane
109	CWT PARTS WASHER			
110	PLANT 1 WOODWORKING AREAS 1A & 1B			
111	PLANT 2 WOODWORKING AREAS 2A-2F			
112	PLANT 3 WOODWORKING AREAS 3A-3D/3F/3G(5A)			
113	PLANT 4 WOODWORKING AREAS 4A/4D/4E			
114	CUSTOMER SERVICE GENERATOR (CWS3789)			
115	WAREHOUSE GENERATOR (CWS3770)			
116	PLANT 1 & 2 EMERGENCY GENERATOR (CWS3423)			
121	FIRE PUMP ENGINE (CWS251)			
122	PLANT #7 GENERATOR (CWS4073)			
123	NOC GENERATOR (CWS4547)			
201	PLANT 5 SPRAY BOOTHS			
202	PLANT 7 SPRAY BOOTHS			
205	LAB COAT SPRAY BOOTH			
206	RECIPROCATING SPRAY LINE/OVENS VENJAKOB NO. 1			
207	RECIPROCATING SPRAY LINE/OVENS VENJAKOB NO. 2			
208	RECIPROCATING SPRAY LINE/OVENS VENJAKOB NO. 3			
221	SHAVING STORAGE BIN 1, PLANT 1			
222	SHAVING STORAGE BIN 2, PLANT 3			
610C	GASOLINE STORAGE TANK, 5000 GAL UG			
C102A	CONTROL, PLANT 1 SYS.A			
C102B	CONTROL, PLANT 1 SYS.B			
C103A	CONTROL, PLANT 2 SYS.A			
C103B	CONTROL, PLANT 2 SYS.B			
C103C	CONTROL, PLANT 2 SYS.C			
C103D	CONTROL, PLANT 2 SYS.D			
C103E	CONTROL, PLANT 2 SYS.E			
C103F	CONTROL, PLANT 2 SYS.F			
C105A	CONTROL, PLANT 3 SYS.A			
C105B	CONTROL, PLANT 3 SYS.B			
C105C	CONTROL, PLANT 3 SYS.C			
C105D	CONTROL, PLANT 3 SYS.D			
C105F	CONTROL, PLANT 3 SYS.F			
C105G	CONTROL, PLANT 3 SYS.G (5A)			
C106A	CONTROL, PLANT 4 SYS.A			
C106D	CONTROL, PLANT 4 SYS.D			

**SECTION A. Site Inventory List**

Source ID	Source Name	Capacity/Throughput	Fuel/Material
C106E	CONTROL, PLANT 4 SYS.E		
C201	CONTROL/PLANT 5: BOOTHS 201A - 201J		
C202	CONTROL/PLANT 7: 202A - 202E AND 202X		
C205	CONTROL, LAB COAT SPRAY BOOTH		
C206	SPRAY BOOTH FILTERS/VENJAKOB NO. 1		
C207	SPRAY BOOTH FILTERS/VENJAKOB NO. 2		
C208	SPRAY BOOTH FILTERS/VENJAKOB NO. 3		
C221A	CONTROL, SHAVING STORAGE BIN 1		
C221B	CONTROL, SHAVING STORAGE BIN 1		
C222A	CONTROL, SHAVING STORAGE BIN 2		
C222B	CONTROL, SHAVING STORAGE BIN 2		
FM001	PROPANE TANK(S)		
FM002	#2 OIL TANKS		
FM003	DIESEL		
S102A	STACK, PLANT 1 SYS.A		
S102B	STACK, PLANT 1 SYS.B		
S103A	STACK, PLANT 2 SYS.A		
S103B	STACK, PLANT 2 SYS.B		
S103C	STACK, PLANT 2 SYS.C		
S103D	STACK, PLANT 2 SYS.D		
S103E	STACK, PLANT 2 SYS.E		
S103F	STACK, PLANT 2 SYS.F		
S105A	STACK, PLANT 3 SYS.A		
S105B	STACK, PLANT 3 SYS.B		
S105C	STACK, PLANT 3 SYS.C		
S105D	STACK, PLANT 3 SYS.D		
S105F	STACK, PLANT 3 SYS.F		
S105G	STACK, PLANT 3 SYS.G (5A)		
S106A	STACK, PLANT 4 SYS.A		
S106D	STACK, PLANT 4 SYS.D		
S106E	STACK, PLANT 4 SYS.E		
S201A	STACK, PLANT 5		
S201B	STACK, PLANT 5		
S201C	STACK, PLANT 5		
S201D	STACK, PLANT 5		
S201E	STACK, PLANT 5		
S201F	STACK, PLANT 5		
S201G	STACK, PLANT 5		
S201H	STACK, PLANT 5		
S201I	STACK, PLANT 5		

**SECTION A. Site Inventory List**

Source ID	Source Name	Capacity/Throughput	Fuel/Material
S201J	STACK, PLANT 5		
S202A	STACK, PLANT 7		
S202B	STACK, PLANT 7		
S202C	STACK, PLANT 7		
S202D	STACK, PLANT 7		
S202E	STACK, PLANT 7		
S202X	STACK, PLANT 7		
S205	STACK, LAB COAT SPRY BTH		
S206A	VERTICAL FLASH OFF OVEN CHAMBER EXHAUST(VARIOTIME)		
S206B	MAIN HVIR OVEN EXHAUST		
S206C	MAIN SPRAY BOOTH EXHAUST		
S207A	VERTICAL FLASH OFF OVEN CHAMBER EXHAUST (VARIOTIME)		
S207B	MAIN HVIR OVEN STACK		
S207C	MAIN SPRAY BOOTH STACK		
S208A	VERTICAL OVEN STACK		
S208B	HVIR TUNNEL STACK		
S208C	SPRAY BOOTH STACK		
S221	STACK, SHAVING BIN 1		
S222	STACK, SHAVING BIN 2		
S35	STACK, AIR MAKEUP UNITS 1 THRU 10		
Z01	FUGITIVE, BOOTHS, PLANTS 5 & 7		
Z109	FUGITIVE EMISSIONS-CWT PARTS WASHER		
Z114	FUGITIVE EMISSIONS - CUSTOMER SERVICE GENERATOR		
Z115	FUGITIVE EMISSIONS - WAREHOUSE GENERATOR		
Z116	FUGITIVE EMISSIONS - PLANT 1 & 2 EMERGENCY GENERATOR		
Z121	FUGITIVE EMISSIONS - FIRE PUMP ENGINE		
Z122	FUGITIVE EMISSIONS - PLANT #7 GENERATOR		
Z123	FUGITIVE EMISSIONS - NOC GENERATOR		
Z21	FUGITIVE, SHAVING STORAGE BIN 1, PLANT 1		
Z22	FUGITIVE, SHAVING STORAGE BIN 2, PLANT 3		
Z31	FUGITIVE, AREA HEATER		
Z610C	FUGITIVE, GAS TANK		

PERMIT MAPS



PERMIT MAPS

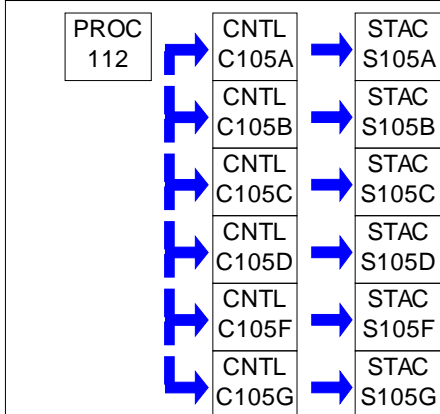
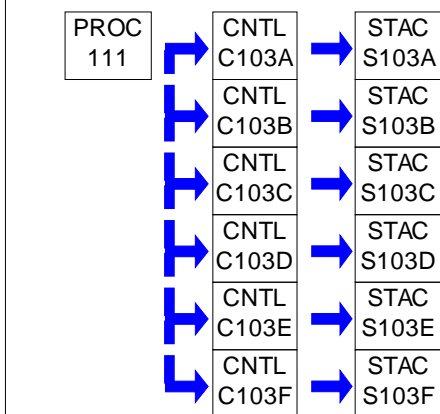
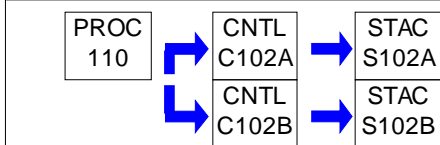
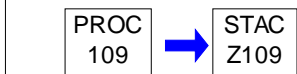
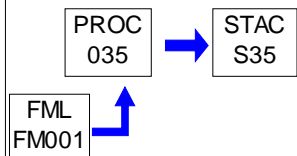
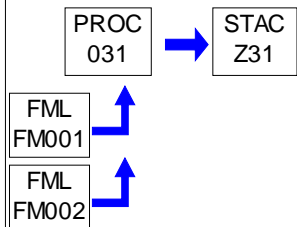



PERMIT MAPS

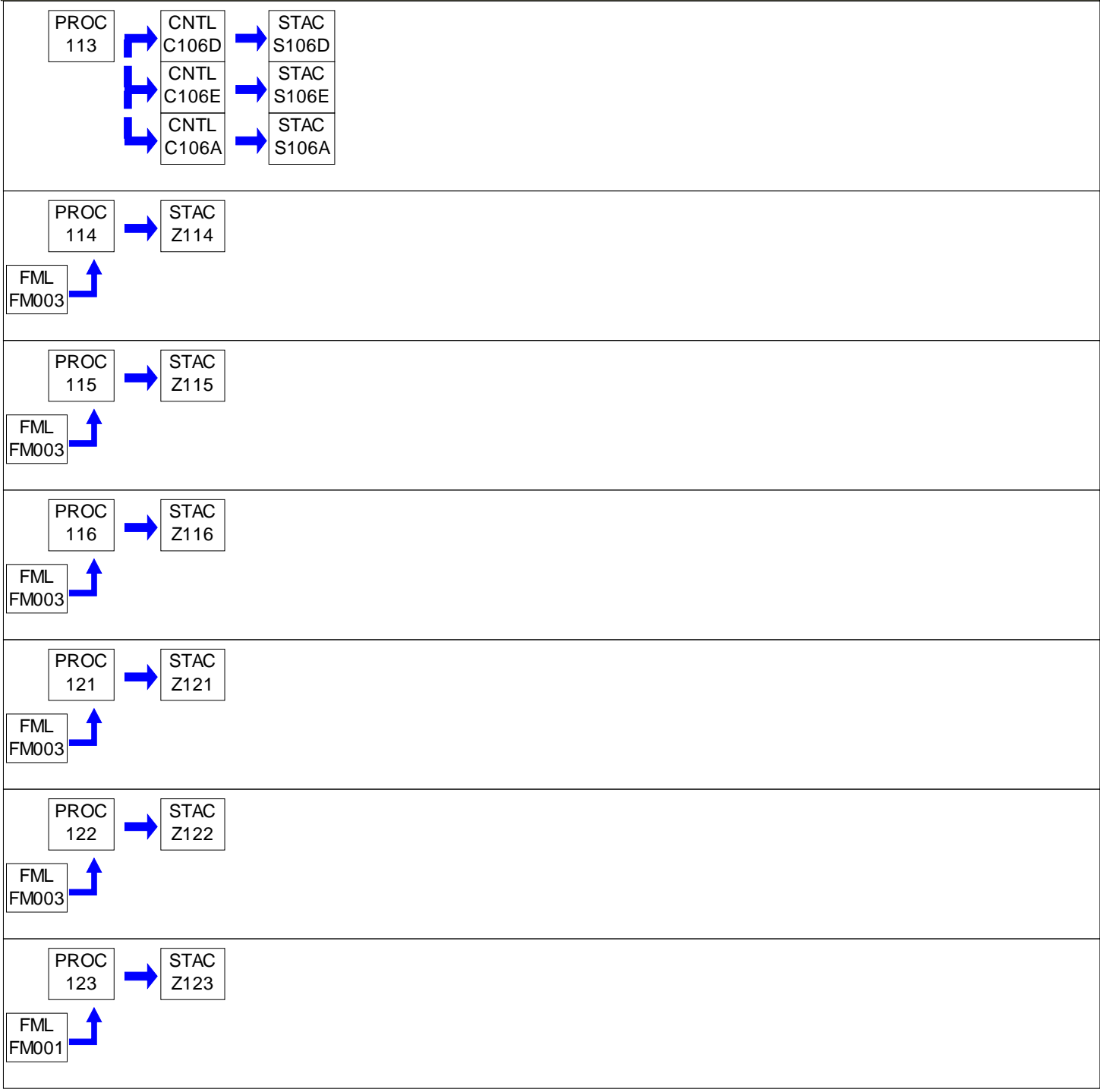



PERMIT MAPS

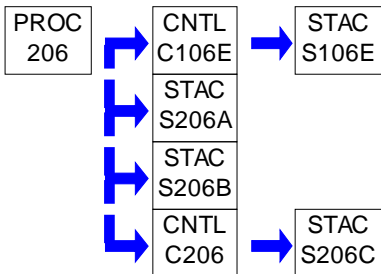
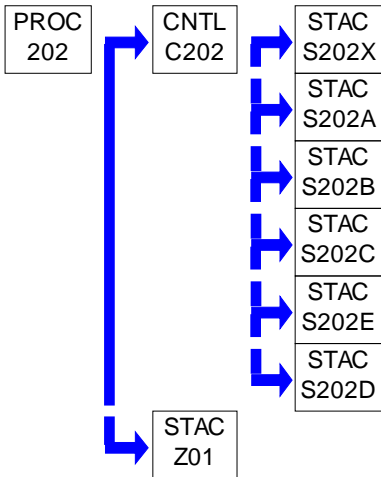
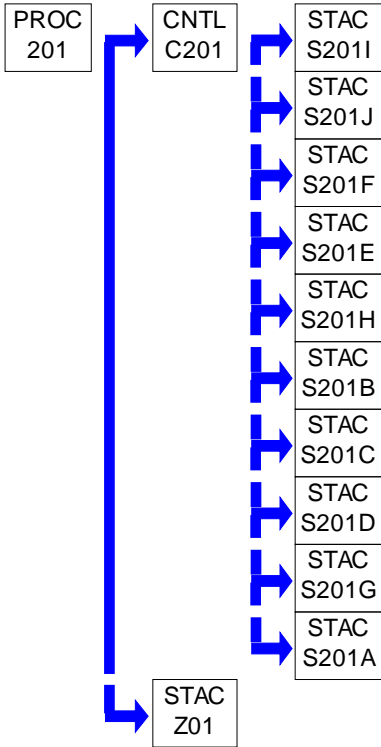



PERMIT MAPS

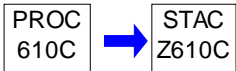
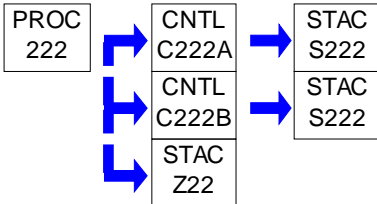
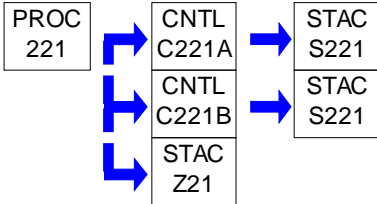
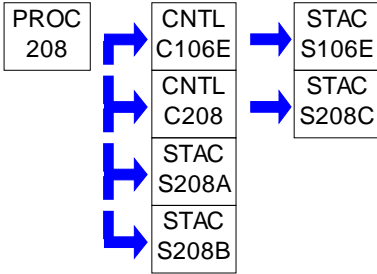
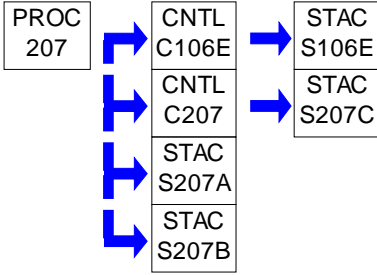

**SECTION B. General Title V Requirements****#001 [25 Pa. Code § 121.1]****Definitions**

Words and terms that are not otherwise defined in this permit shall have the meanings set forth in Section 3 of the Air Pollution Control Act (35 P.S. § 4003) and 25 Pa. Code § 121.1.

#002 [25 Pa. Code § 121.7]**Prohibition of Air Pollution**

No person may permit air pollution as that term is defined in the act.

#003 [25 Pa. Code § 127.512(c)(4)]**Property Rights**

This permit does not convey property rights of any sort, or any exclusive privileges.

#004 [25 Pa. Code § 127.446(a) and (c)]**Permit Expiration**

This operating permit is issued for a fixed term of five (5) years and shall expire on the date specified on Page 1 of this permit. The terms and conditions of the expired permit shall automatically continue pending issuance of a new Title V permit, provided the permittee has submitted a timely and complete application and paid applicable fees required under 25 Pa. Code Chapter 127, Subchapter I and the Department is unable, through no fault of the permittee, to issue or deny a new permit before the expiration of the previous permit. An application is complete if it contains sufficient information to begin processing the application, has the applicable sections completed and has been signed by a responsible official.

#005 [25 Pa. Code §§ 127.412, 127.413, 127.414, 127.446(e), 127.503 & 127.704(b)]**Permit Renewal**

(a) An application for the renewal of the Title V permit shall be submitted to the Department at least six (6) months, and not more than 18 months, before the expiration date of this permit. The renewal application is timely if a complete application is submitted to the Department's Regional Air Manager within the timeframe specified in this permit condition.

(b) The application for permit renewal shall include the current permit number, the appropriate permit renewal fee, a description of any permit revisions and off-permit changes that occurred during the permit term, and any applicable requirements that were promulgated and not incorporated into the permit during the permit term. The fees shall be made payable to "The Commonwealth of Pennsylvania Clean Air Fund" and submitted with the fee form to the respective regional office.

(c) The renewal application shall also include submission of proof that the local municipality and county, in which the facility is located, have been notified in accordance with 25 Pa. Code § 127.413. The application for renewal of the Title V permit shall also include submission of compliance review forms which have been used by the permittee to update information submitted in accordance with either 25 Pa. Code § 127.412(b) or § 127.412(j).

(d) The permittee, upon becoming aware that any relevant facts were omitted or incorrect information was submitted in the permit application, shall promptly submit such supplementary facts or corrected information during the permit renewal process. The permittee shall also promptly provide additional information as necessary to address any requirements that become applicable to the source after the date a complete renewal application was submitted but prior to release of a draft permit.

#006 [25 Pa. Code §§ 127.450(a)(4) & 127.464(a)]**Transfer of Ownership or Operational Control**

(a) In accordance with 25 Pa. Code § 127.450(a)(4), a change in ownership or operational control of the source shall be treated as an administrative amendment if:

- (1) The Department determines that no other change in the permit is necessary;
- (2) A written agreement has been submitted to the Department identifying the specific date of the transfer of permit responsibility, coverage and liability between the current and the new permittee; and,
- (3) A compliance review form has been submitted to the Department and the permit transfer has been approved by

**SECTION B. General Title V Requirements**

the Department.

(b) In accordance with 25 Pa. Code § 127.464(a), this permit may not be transferred to another person except in cases of transfer-of-ownership which are documented and approved to the satisfaction of the Department.

#007 [25 Pa. Code § 127.513, 35 P.S. § 4008 and § 114 of the CAA]**Inspection and Entry**

(a) Upon presentation of credentials and other documents as may be required by law for inspection and entry purposes, the permittee shall allow the Department of Environmental Protection or authorized representatives of the Department to perform the following:

- (1) Enter at reasonable times upon the permittee's premises where a Title V source is located or emissions related activity is conducted, or where records are kept under the conditions of this permit;
- (2) Have access to and copy or remove, at reasonable times, records that are kept under the conditions of this permit;
- (3) Inspect at reasonable times, facilities, equipment including monitoring and air pollution control equipment, practices, or operations regulated or required under this permit;
- (4) Sample or monitor, at reasonable times, substances or parameters, for the purpose of assuring compliance with the permit or applicable requirements as authorized by the Clean Air Act, the Air Pollution Control Act, or the regulations promulgated under the Acts.

(b) Pursuant to 35 P.S. § 4008, no person shall hinder, obstruct, prevent or interfere with the Department or its personnel in the performance of any duty authorized under the Air Pollution Control Act.

(c) Nothing in this permit condition shall limit the ability of the EPA to inspect or enter the premises of the permittee in accordance with Section 114 or other applicable provisions of the Clean Air Act.

#008 [25 Pa. Code §§ 127.25, 127.444, & 127.512(c)(1)]**Compliance Requirements**

(a) The permittee shall comply with the conditions of this permit. Noncompliance with this permit constitutes a violation of the Clean Air Act and the Air Pollution Control Act and is grounds for one (1) or more of the following:

- (1) Enforcement action
- (2) Permit termination, revocation and reissuance or modification
- (3) Denial of a permit renewal application

(b) A person may not cause or permit the operation of a source, which is subject to 25 Pa. Code Article III, unless the source(s) and air cleaning devices identified in the application for the plan approval and operating permit and the plan approval issued to the source are operated and maintained in accordance with specifications in the applications and the conditions in the plan approval and operating permit issued by the Department. A person may not cause or permit the operation of an air contamination source subject to 25 Pa. Code Chapter 127 in a manner inconsistent with good operating practices.

(c) For purposes of Sub-condition (b) of this permit condition, the specifications in applications for plan approvals and operating permits are the physical configurations and engineering design details which the Department determines are essential for the permittee's compliance with the applicable requirements in this Title V permit.

#009 [25 Pa. Code § 127.512(c)(2)]**Need to Halt or Reduce Activity Not a Defense**

It shall not be a defense for a permittee in an enforcement action that it would have been necessary to halt or reduce the permitted activity in order to maintain compliance with the conditions of this permit.

**SECTION B. General Title V Requirements****#010 [25 Pa. Code §§ 127.411(d) & 127.512(c)(5)]****Duty to Provide Information**

(a) The permittee shall furnish to the Department, within a reasonable time, information that the Department may request in writing to determine whether cause exists for modifying, revoking and reissuing, or terminating the permit, or to determine compliance with the permit.

(b) Upon request, the permittee shall also furnish to the Department copies of records that the permittee is required to keep by this permit, or for information claimed to be confidential, the permittee may furnish such records directly to the Administrator of EPA along with a claim of confidentiality.

#011 [25 Pa. Code §§ 127.463, 127.512(c)(3) & 127.542]**Reopening and Revising the Title V Permit for Cause**

(a) This Title V permit may be modified, revoked, reopened and reissued or terminated for cause. The filing of a request by the permittee for a permit modification, revocation and reissuance, or termination, or of a notification of planned changes or anticipated noncompliance does not stay a permit condition.

(b) This permit may be reopened, revised and reissued prior to expiration of the permit under one or more of the following circumstances:

(1) Additional applicable requirements under the Clean Air Act or the Air Pollution Control Act become applicable to a Title V facility with a remaining permit term of three (3) or more years prior to the expiration date of this permit. The Department will revise the permit as expeditiously as practicable but not later than 18 months after promulgation of the applicable standards or regulations. No such revision is required if the effective date of the requirement is later than the expiration date of this permit, unless the original permit or its terms and conditions has been extended.

(2) Additional requirements, including excess emissions requirements, become applicable to an affected source under the acid rain program. Upon approval by the Administrator of EPA, excess emissions offset plans for an affected source shall be incorporated into the permit.

(3) The Department or the EPA determines that this permit contains a material mistake or inaccurate statements were made in establishing the emissions standards or other terms or conditions of this permit.

(4) The Department or the Administrator of EPA determines that the permit must be revised or revoked to assure compliance with the applicable requirements.

(c) Proceedings to revise this permit shall follow the same procedures which apply to initial permit issuance and shall affect only those parts of this permit for which cause to revise exists. The revision shall be made as expeditiously as practicable.

(d) Regardless of whether a revision is made in accordance with (b)(1) above, the permittee shall meet the applicable standards or regulations promulgated under the Clean Air Act within the time frame required by standards or regulations.

#012 [25 Pa. Code § 127.543]**Reopening a Title V Permit for Cause by EPA**

As required by the Clean Air Act and regulations adopted thereunder, this permit may be modified, reopened and reissued, revoked or terminated for cause by EPA in accordance with procedures specified in 25 Pa. Code § 127.543.

#013 [25 Pa. Code § 127.522(a)]**Operating Permit Application Review by the EPA**

The applicant may be required by the Department to provide a copy of the permit application, including the compliance plan, directly to the Administrator of the EPA. Copies of title V permit applications to EPA, pursuant to 25 PA Code §127.522(a), shall be submitted, if required, to the following EPA e-mail box:

R3_Air_Apps_and_Notices@epa.gov

Please place the following in the subject line: TV [permit number], [Facility Name].

**SECTION B. General Title V Requirements****#014 [25 Pa. Code § 127.541]****Significant Operating Permit Modifications**

When permit modifications during the term of this permit do not qualify as minor permit modifications or administrative amendments, the permittee shall submit an application for significant Title V permit modifications in accordance with 25 Pa. Code § 127.541. Notifications to EPA, pursuant to 25 PA Code §127.522(a), if required, shall be submitted, to the following EPA e-mail box:

R3_Air_Apps_and_Notices@epa.gov

Please place the following in the subject line: TV [permit number], [Facility Name].

#015 [25 Pa. Code §§ 121.1 & 127.462]**Minor Operating Permit Modifications**

The permittee may make minor operating permit modifications (as defined in 25 Pa. Code §121.1), on an expedited basis, in accordance with 25 Pa. Code §127.462 (relating to minor operating permit modifications). Notifications to EPA, pursuant to 25 PA Code §127.462(c), if required, shall be submitted, to the following EPA e-mail box:

R3_Air_Apps_and_Notices@epa.gov

Please place the following in the subject line: TV [permit number], [Facility Name].

#016 [25 Pa. Code § 127.450]**Administrative Operating Permit Amendments**

(a) The permittee may request administrative operating permit amendments, as defined in 25 Pa. Code §127.450(a). Copies of request for administrative permit amendment to EPA, pursuant to 25 PA Code §127.450(c)(1), if required, shall be submitted to the following EPA e-mail box:

R3_Air_Apps_and_Notices@epa.gov

Please place the following in the subject line: TV [permit number], [Facility Name].

(b) Upon final action by the Department granting a request for an administrative operating permit amendment covered under §127.450(a)(5), the permit shield provisions in 25 Pa. Code § 127.516 (relating to permit shield) shall apply to administrative permit amendments incorporated in this Title V Permit in accordance with §127.450(c), unless precluded by the Clean Air Act or the regulations thereunder.

#017 [25 Pa. Code § 127.512(b)]**Severability Clause**

The provisions of this permit are severable, and if any provision of this permit is determined by the Environmental Hearing Board or a court of competent jurisdiction, or US EPA to be invalid or unenforceable, such a determination will not affect the remaining provisions of this permit.

#018 [25 Pa. Code §§ 127.704, 127.705 & 127.707]**Fee Payment**

(a) The permittee shall pay fees to the Department in accordance with the applicable fee schedules in 25 Pa. Code Chapter 127, Subchapter I (relating to plan approval and operating permit fees). The applicable fees shall be made payable to "The Commonwealth of Pennsylvania Clean Air Fund" with the permit number clearly indicated and submitted to the respective regional office.

(b) Emission Fees. The permittee shall, on or before September 1st of each year, pay applicable annual Title V emission fees for emissions occurring in the previous calendar year as specified in 25 Pa. Code § 127.705. The permittee is not required to pay an emission fee for emissions of more than 4,000 tons of each regulated pollutant emitted from the facility.

(c) As used in this permit condition, the term "regulated pollutant" is defined as a VOC, each pollutant regulated under Sections 111 and 112 of the Clean Air Act and each pollutant for which a National Ambient Air Quality Standard has been promulgated, except that carbon monoxide is excluded.

**SECTION B. General Title V Requirements**

(d) Late Payment. Late payment of emission fees will subject the permittee to the penalties prescribed in 25 Pa. Code § 127.707 and may result in the suspension or termination of the Title V permit. The permittee shall pay a penalty of fifty percent (50%) of the fee amount, plus interest on the fee amount computed in accordance with 26 U.S.C.A. § 6621(a)(2) from the date the emission fee should have been paid in accordance with the time frame specified in 25 Pa. Code § 127.705(c).

(e) The permittee shall pay an annual operating permit maintenance fee according to the following fee schedule established in 25 Pa. Code § 127.704(d) on or before December 31 of each year for the next calendar year.

- (1) Eight thousand dollars (\$8,000) for calendar years 2021—2025.
- (2) Ten thousand dollars (\$10,000) for calendar years 2026—2030.
- (3) Twelve thousand five hundred dollars (\$12,500) for the calendar years beginning with 2031.

#019 [25 Pa. Code §§ 127.14(b) & 127.449]**Authorization for De Minimis Emission Increases**

(a) This permit authorizes de minimis emission increases from a new or existing source in accordance with 25 Pa. Code §§ 127.14 and 127.449 without the need for a plan approval or prior issuance of a permit modification. The permittee shall provide the Department with seven (7) days prior written notice before commencing any de minimis emissions increase that would result from either: (1) a physical change of minor significance under § 127.14(c)(1); or (2) the construction, installation, modification or reactivation of an air contamination source. The written notice shall:

- (1) Identify and describe the pollutants that will be emitted as a result of the de minimis emissions increase.
- (2) Provide emission rates expressed in tons per year and in terms necessary to establish compliance consistent with any applicable requirement.

The Department may disapprove or condition de minimis emission increases at any time.

(b) Except as provided below in (c) and (d) of this permit condition, the permittee is authorized during the term of this permit to make de minimis emission increases (expressed in tons per year) up to the following amounts without the need for a plan approval or prior issuance of a permit modification:

- (1) Four tons of carbon monoxide from a single source during the term of the permit and 20 tons of carbon monoxide at the facility during the term of the permit.
- (2) One ton of NO_x from a single source during the term of the permit and 5 tons of NO_x at the facility during the term of the permit.
- (3) One and six-tenths tons of the oxides of sulfur from a single source during the term of the permit and 8.0 tons of oxides of sulfur at the facility during the term of the permit.
- (4) Six-tenths of a ton of PM₁₀ from a single source during the term of the permit and 3.0 tons of PM₁₀ at the facility during the term of the permit. This shall include emissions of a pollutant regulated under Section 112 of the Clean Air Act unless precluded by the Clean Air Act or 25 Pa. Code Article III.
- (5) One ton of VOCs from a single source during the term of the permit and 5.0 tons of VOCs at the facility during the term of the permit. This shall include emissions of a pollutant regulated under Section 112 of the Clean Air Act unless precluded by the Clean Air Act or 25 Pa. Code Article III.

(c) In accordance with § 127.14, the permittee may install the following minor sources without the need for a plan approval:

- (1) Air conditioning or ventilation systems not designed to remove pollutants generated or released from other sources.
- (2) Combustion units rated at 2,500,000 or less Btu per hour of heat input.

**SECTION B. General Title V Requirements**

(3) Combustion units with a rated capacity of less than 10,000,000 Btu per hour heat input fueled by natural gas supplied by a public utility, liquefied petroleum gas or by commercial fuel oils which are No. 2 or lighter, viscosity less than or equal to 5.82 c St, and which meet the sulfur content requirements of 25 Pa. Code § 123.22 (relating to combustion units). For purposes of this permit, commercial fuel oil shall be virgin oil which has no reprocessed, recycled or waste material added.

(4) Space heaters which heat by direct heat transfer.

(5) Laboratory equipment used exclusively for chemical or physical analysis.

(6) Other sources and classes of sources determined to be of minor significance by the Department.

(d) This permit does not authorize de minimis emission increases if the emissions increase would cause one or more of the following:

(1) Increase the emissions of a pollutant regulated under Section 112 of the Clean Air Act except as authorized in Subparagraphs (b)(4) and (5) of this permit condition.

(2) Subject the facility to the prevention of significant deterioration requirements in 25 Pa. Code Chapter 127, Subchapter D and/or the new source review requirements in Subchapter E.

(3) Violate any applicable requirement of the Air Pollution Control Act, the Clean Air Act, or the regulations promulgated under either of the acts.

(4) Changes which are modifications under any provision of Title I of the Clean Air Act and emission increases which would exceed the allowable emissions level (expressed as a rate of emissions or in terms of total emissions) under the Title V permit.

(e) Unless precluded by the Clean Air Act or the regulations thereunder, the permit shield described in 25 Pa. Code § 127.516 (relating to permit shield) shall extend to the changes made under 25 Pa. Code § 127.449 (relating to de minimis emission increases).

(f) Emissions authorized under this permit condition shall be included in the monitoring, recordkeeping and reporting requirements of this permit.

(g) Except for de minimis emission increases allowed under this permit, 25 Pa. Code § 127.449, or sources and physical changes meeting the requirements of 25 Pa. Code § 127.14, the permittee is prohibited from making physical changes or engaging in activities that are not specifically authorized under this permit without first applying for a plan approval. In accordance with § 127.14(b), a plan approval is not required for the construction, modification, reactivation, or installation of the sources creating the de minimis emissions increase.

(h) The permittee may not meet de minimis emission threshold levels by offsetting emission increases or decreases at the same source.

#020 [25 Pa. Code §§ 127.11a & 127.215]**Reactivation of Sources**

(a) The permittee may reactivate a source at the facility that has been out of operation or production for at least one year, but less than or equal to five (5) years, if the source is reactivated in accordance with the requirements of 25 Pa. Code §§ 127.11a and 127.215. The reactivated source will not be considered a new source.

(b) A source which has been out of operation or production for more than five (5) years but less than 10 years may be reactivated and will not be considered a new source if the permittee satisfies the conditions specified in 25 Pa. Code § 127.11a(b).

#021 [25 Pa. Code §§ 121.9 & 127.216]**Circumvention**

(a) The owner of this Title V facility, or any other person, may not circumvent the new source review requirements of 25 Pa. Code Chapter 127, Subchapter E by causing or allowing a pattern of ownership or development, including the

**SECTION B. General Title V Requirements**

phasing, staging, delaying or engaging in incremental construction, over a geographic area of a facility which, except for the pattern of ownership or development, would otherwise require a permit or submission of a plan approval application.

(b) No person may permit the use of a device, stack height which exceeds good engineering practice stack height, dispersion technique or other technique which, without resulting in reduction of the total amount of air contaminants emitted, conceals or dilutes an emission of air contaminants which would otherwise be in violation of this permit, the Air Pollution Control Act or the regulations promulgated thereunder, except that with prior approval of the Department, the device or technique may be used for control of malodors.

#022 [25 Pa. Code §§ 127.402(d) & 127.513(1)]**Submissions**

(a) Reports, test data, monitoring data, notifications and requests for renewal of the permit shall be submitted to the:

Regional Air Program Manager
PA Department of Environmental Protection
(At the address given on the permit transmittal letter, or otherwise notified)

(b) Any report or notification for the EPA Administrator or EPA Region III should be addressed to:

Enforcement & Compliance Assurance Division
Air, RCRA and Toxics Branch (3ED21)
Four Penn Center
1600 John F. Kennedy Boulevard
Philadelphia, PA 19103-2852

The Title V compliance certification shall be emailed to EPA at R3_APD_Permits@epa.gov.

(c) An application, form, report or compliance certification submitted pursuant to this permit condition shall contain certification by a responsible official as to truth, accuracy, and completeness as required under 25 Pa. Code § 127.402(d). Unless otherwise required by the Clean Air Act or regulations adopted thereunder, this certification and any other certification required pursuant to this permit shall state that, based on information and belief formed after reasonable inquiry, the statements and information in the document are true, accurate and complete.

#023 [25 Pa. Code §§ 127.441(c) & 127.463(e); Chapter 139; & 114(a)(3), 504(b) of the CAA]**Sampling, Testing and Monitoring Procedures**

(a) The permittee shall perform the emissions monitoring and analysis procedures or test methods for applicable requirements of this Title V permit. In addition to the sampling, testing and monitoring procedures specified in this permit, the Permittee shall comply with any additional applicable requirements promulgated under the Clean Air Act after permit issuance regardless of whether the permit is revised.

(b) The sampling, testing and monitoring required under the applicable requirements of this permit, shall be conducted in accordance with the requirements of 25 Pa. Code Chapter 139 unless alternative methodology is required by the Clean Air Act (including §§ 114(a)(3) and 504(b)) and regulations adopted thereunder.

#024 [25 Pa. Code § 127.513]**Compliance Certification**

(a) One year after the date of issuance of the Title V permit, and each year thereafter, unless specified elsewhere in the permit, the permittee shall submit to the Department and EPA Region III a certificate of compliance with the terms and conditions in this permit, for the previous year, including the emission limitations, standards or work practices. This certification shall include:

- (1) The identification of each term or condition of the permit that is the basis of the certification.
- (2) The compliance status.
- (3) The methods used for determining the compliance status of the source, currently and over the reporting period.
- (4) Whether compliance was continuous or intermittent.

(b) The compliance certification shall be postmarked or hand-delivered no later than thirty days after each anniversary of

**SECTION B. General Title V Requirements**

the date of issuance of this Title V Operating Permit, or on the submittal date specified elsewhere in the permit, to the Department in accordance with the submission requirements specified in Section B, Condition #022 of this permit. The Title V compliance certification shall be emailed to EPA at R3_APD_Permits@epa.gov.

#025 [25 Pa. Code §§ 127.511 & Chapter 135]**Recordkeeping Requirements**

(a) The permittee shall maintain and make available, upon request by the Department, records of required monitoring information that include the following:

- (1) The date, place (as defined in the permit) and time of sampling or measurements.
- (2) The dates the analyses were performed.
- (3) The company or entity that performed the analyses.
- (4) The analytical techniques or methods used.
- (5) The results of the analyses.
- (6) The operating conditions as existing at the time of sampling or measurement.

(b) The permittee shall retain records of the required monitoring data and supporting information for at least five (5) years from the date of the monitoring sample, measurement, report or application. Supporting information includes the calibration data and maintenance records and original strip-chart recordings for continuous monitoring instrumentation, and copies of reports required by the permit.

(c) The permittee shall maintain and make available to the Department upon request, records including computerized records that may be necessary to comply with the reporting, recordkeeping and emission statement requirements in 25 Pa. Code Chapter 135 (relating to reporting of sources). In accordance with 25 Pa. Code Chapter 135, § 135.5, such records may include records of production, fuel usage, maintenance of production or pollution control equipment or other information determined by the Department to be necessary for identification and quantification of potential and actual air contaminant emissions. If direct recordkeeping is not possible or practical, sufficient records shall be kept to provide the needed information by indirect means.

#026 [25 Pa. Code §§ 127.411(d), 127.442, 127.463(e) & 127.511(c)]**Reporting Requirements**

(a) The permittee shall comply with the reporting requirements for the applicable requirements specified in this Title V permit. In addition to the reporting requirements specified herein, the permittee shall comply with any additional applicable reporting requirements promulgated under the Clean Air Act after permit issuance regardless of whether the permit is revised.

(b) Pursuant to 25 Pa. Code § 127.511(c), the permittee shall submit reports of required monitoring at least every six (6) months unless otherwise specified in this permit. Instances of deviations (as defined in 25 Pa. Code § 121.1) from permit requirements shall be clearly identified in the reports. The reporting of deviations shall include the probable cause of the deviations and corrective actions or preventative measures taken, except that sources with continuous emission monitoring systems shall report according to the protocol established and approved by the Department for the source. The required reports shall be certified by a responsible official.

(c) Every report submitted to the Department under this permit condition shall comply with the submission procedures specified in Section B, Condition #022(c) of this permit.

(d) Any records, reports or information obtained by the Department or referred to in a public hearing shall be made available to the public by the Department except for such records, reports or information for which the permittee has shown cause that the documents should be considered confidential and protected from disclosure to the public under Section 4013.2 of the Air Pollution Control Act and consistent with Sections 112(d) and 114(c) of the Clean Air Act and 25 Pa. Code § 127.411(d). The permittee may not request a claim of confidentiality for any emissions data generated for the Title V facility.

**SECTION B. General Title V Requirements****#027 [25 Pa. Code § 127.3]****Operational Flexibility**

The permittee is authorized to make changes within the Title V facility in accordance with the following provisions in 25 Pa. Code Chapter 127 which implement the operational flexibility requirements of Section 502(b)(10) of the Clean Air Act and Section 6.1(i) of the Air Pollution Control Act:

- (1) Section 127.14 (relating to exemptions)
- (2) Section 127.447 (relating to alternative operating scenarios)
- (3) Section 127.448 (relating to emissions trading at facilities with federally enforceable emissions caps)
- (4) Section 127.449 (relating to de minimis emission increases)
- (5) Section 127.450 (relating to administrative operating permit amendments)
- (6) Section 127.462 (relating to minor operating permit amendments)
- (7) Subchapter H (relating to general plan approvals and operating permits)

#028 [25 Pa. Code §§ 127.441(d), 127.512(i) and 40 CFR Part 68]**Risk Management**

(a) If required by Section 112(r) of the Clean Air Act, the permittee shall develop and implement an accidental release program consistent with requirements of the Clean Air Act, 40 CFR Part 68 (relating to chemical accident prevention provisions) and the Federal Chemical Safety Information, Site Security and Fuels Regulatory Relief Act (P.L. 106-40).

(b) The permittee shall prepare and implement a Risk Management Plan (RMP) which meets the requirements of Section 112(r) of the Clean Air Act, 40 CFR Part 68 and the Federal Chemical Safety Information, Site Security and Fuels Regulatory Relief Act when a regulated substance listed in 40 CFR § 68.130 is present in a process in more than the listed threshold quantity at the Title V facility. The permittee shall submit the RMP to the federal Environmental Protection Agency according to the following schedule and requirements:

- (1) The permittee shall submit the first RMP to a central point specified by EPA no later than the latest of the following:
 - (i) Three years after the date on which a regulated substance is first listed under § 68.130; or,
 - (ii) The date on which a regulated substance is first present above a threshold quantity in a process.

(2) The permittee shall submit any additional relevant information requested by the Department or EPA concerning the RMP and shall make subsequent submissions of RMPs in accordance with 40 CFR § 68.190.

(3) The permittee shall certify that the RMP is accurate and complete in accordance with the requirements of 40 CFR Part 68, including a checklist addressing the required elements of a complete RMP.

(c) As used in this permit condition, the term "process" shall be as defined in 40 CFR § 68.3. The term "process" means any activity involving a regulated substance including any use, storage, manufacturing, handling, or on-site movement of such substances or any combination of these activities. For purposes of this definition, any group of vessels that are interconnected, or separate vessels that are located such that a regulated substance could be involved in a potential release, shall be considered a single process.

(d) If the Title V facility is subject to 40 CFR Part 68, as part of the certification required under this permit, the permittee shall:

- (1) Submit a compliance schedule for satisfying the requirements of 40 CFR Part 68 by the date specified in 40 CFR § 68.10(a); or,
- (2) Certify that the Title V facility is in compliance with all requirements of 40 CFR Part 68 including the registration and submission of the RMP.

**SECTION B. General Title V Requirements**

(e) If the Title V facility is subject to 40 CFR Part 68, the permittee shall maintain records supporting the implementation of an accidental release program for five (5) years in accordance with 40 CFR § 68.200.

(f) When the Title V facility is subject to the accidental release program requirements of Section 112(r) of the Clean Air Act and 40 CFR Part 68, appropriate enforcement action will be taken by the Department if:

(1) The permittee fails to register and submit the RMP or a revised plan pursuant to 40 CFR Part 68.

(2) The permittee fails to submit a compliance schedule or include a statement in the compliance certification required under Section B, Condition #026 of this permit that the Title V facility is in compliance with the requirements of Section 112(r) of the Clean Air Act, 40 CFR Part 68, and 25 Pa. Code § 127.512(i).

#029 [25 Pa. Code § 127.512(e)]**Approved Economic Incentives and Emission Trading Programs**

No permit revision shall be required under approved economic incentives, marketable permits, emissions trading and other similar programs or processes for changes that are provided for in this Title V permit.

#030 [25 Pa. Code §§ 127.516, 127.450(d), 127.449(f) & 127.462(g)]**Permit Shield**

(a) The permittee's compliance with the conditions of this permit shall be deemed in compliance with applicable requirements (as defined in 25 Pa. Code § 121.1) as of the date of permit issuance if either of the following applies:

(1) The applicable requirements are included and are specifically identified in this permit.

(2) The Department specifically identifies in the permit other requirements that are not applicable to the permitted facility or source.

(b) Nothing in 25 Pa. Code § 127.516 or the Title V permit shall alter or affect the following:

(1) The provisions of Section 303 of the Clean Air Act, including the authority of the Administrator of the EPA provided thereunder.

(2) The liability of the permittee for a violation of an applicable requirement prior to the time of permit issuance.

(3) The applicable requirements of the acid rain program, consistent with Section 408(a) of the Clean Air Act.

(4) The ability of the EPA to obtain information from the permittee under Section 114 of the Clean Air Act.

(c) Unless precluded by the Clean Air Act or regulations thereunder, final action by the Department incorporating a significant permit modification in this Title V Permit shall be covered by the permit shield at the time that the permit containing the significant modification is issued.

#031 [25 Pa. Code §135.3]**Reporting**

(a) The permittee shall submit by March 1 of each year an annual emissions report for the preceding calendar year. The report shall include information for all active previously reported sources, new sources which were first operated during the preceding calendar year, and sources modified during the same period which were not previously reported. All air emissions from the facility should be estimated and reported.

(b) A source owner or operator may request an extension of time from the Department for the filing of an annual emissions report, and the Department may grant the extension for reasonable cause.

#032 [25 Pa. Code §135.4]**Report Format**

Emissions reports shall contain sufficient information to enable the Department to complete its emission inventory. Emissions reports shall be made by the source owner or operator in a format specified by the Department.

**SECTION C. Site Level Requirements****I. RESTRICTIONS.****Emission Restriction(s).****# 001 [25 Pa. Code §123.1]****Prohibition of certain fugitive emissions**

The permittee shall not allow the emission into the outdoor atmosphere of any fugitive air contaminant from a source other than the following:

- (a) Construction or demolition of building or structure.
- (b) Grading, paving and maintenance of roads and streets.
- (c) Use of roads and streets. Emissions from material in or on trucks, railroad cars and other vehicular equipment are not considered as emissions from use of roads and streets.
- (d) Clearing of land.
- (e) Stockpiling of material.
- (f) Open burning operations.
- (g) Sources and classes of sources other than those identified in paragraphs (a) through (e), above, for which the operator has obtained a determination from the Department that fugitive emissions from the source, after appropriate control, meet the following requirements:
 - (1) The emissions are of minor significance with respect to causing air pollution.
 - (2) The emissions are not preventing or interfering with the attainment or maintenance of any ambient air standard.

002 [25 Pa. Code §123.2]**Fugitive particulate matter**

The permittee shall not allow the emissions of particulate matter into the outdoor atmosphere from a source specified in Section C, Condition #001 if the emissions are visible at the point the emissions pass outside the permittee's property.

003 [25 Pa. Code §123.31]**Limitations**

The permittee shall not allow the emission into the outdoor atmosphere of any malodorous air contaminants from any source in such a manner that the malodors are detectable outside the permittee's property.

004 [25 Pa. Code §123.41]**Limitations**

The permittee shall not allow the emission into the outdoor atmosphere of visible air contaminants in such a manner that the opacity of the emission is either of the following:

- (a) Equal to or greater than 20 percent for a period or periods aggregating more than three minutes in any one hour.
- (b) Equal to or greater than 60 percent at any time.

005 [25 Pa. Code §123.42]**Exceptions**

The emission limitation of 25 Pa. Code §123.41 shall not apply when:

- (a) The presence of uncombined water is the only reason for failure of the emission to meet the limitation.
- (b) The emission results from the operation of equipment used solely to train and test persons in observing the opacity of visible emissions.
- (c) The emission results from sources specified in Section C, Condition #001.

**SECTION C. Site Level Requirements****# 006 [25 Pa. Code §127.441]****Operating permit terms and conditions.**

The facility VOC emissions shall not exceed 164.0 tons per year for all sources at the facility except Source ID #206. This VOC emission limit is based on a consecutive 12-month rolling period.

007 [25 Pa. Code §129.14]**Open burning operations**

(a) The permittee shall not conduct open burning of materials in such a manner that:

- (1) The emissions are visible, at any time, at the point such emissions pass outside the permittee's property.
- (2) Malodorous air contaminants from the open burning are detectable outside the permittee's property.
- (3) The emissions interfere with the reasonable enjoyment of life and property.
- (4) The emissions cause damage to vegetation or property.
- (5) The emissions are or may be deleterious to human or animal health.

(b) Exceptions. The requirements of Subsection (a) do not apply where the open burning operations result from:

- (1) A fire set to prevent or abate a fire hazard, when approved by the Department and set by or under the supervision of a public official.
- (2) Any fire set for the purpose of instructing personnel in fire fighting, when approved by the Department.
- (3) A fire set for the prevention and control of disease or pests, when approved by the Department.
- (4) A fire set solely for recreational or ceremonial purposes.
- (5) A fire set solely for cooking food.

(c) This permit does not constitute authorization to burn solid waste in violation of Section 610 (3) of the Solid Waste Management Act, 35 P. S. Section 6018.610(3), or any other provision of the Solid Waste Management Act.

II. TESTING REQUIREMENTS.**# 008 [25 Pa. Code §127.511]****Monitoring and related recordkeeping and reporting requirements.**

The Department reserves the right to require exhaust stack testing of sources as necessary during the permit term to verify emissions for purposes including permit condition violations, emission fees or malfunctioning.

III. MONITORING REQUIREMENTS.**# 009 [25 Pa. Code §123.43]****Measuring techniques**

Visible air contaminants may be measured using either of the following:

- (a) A device approved by the Department and maintained to provide accurate opacity measurement.
- (b) Observers, trained and certified in EPA Method 9 to measure plume opacity with the naked eye or with the aid of any device(s) approved by the Department.

010 [25 Pa. Code §127.511]**Monitoring and related recordkeeping and reporting requirements.**

(a) The permittee shall conduct a monthly inspection around the plant periphery during daylight hours when the plant is in production to detect any visible emissions, fugitive emissions, and odorous emissions as follows:

**SECTION C. Site Level Requirements**

(1) Visible emissions in excess of the limits stated in Site Level, condition #004. Visible emissions may be measured according to the methods specified in Site Level Condition #009, or as an alternative, plant personnel who observe such emissions may report the incident of visible emissions to the Department within two (2) hours of each incident, and make arrangements for a certified observer to verify the visible emissions.

(2) The presence of fugitive emissions visible beyond the plant boundaries as stated in Site Level condition # 002.

(3) The presence of malodorous air emissions beyond the plant boundaries as stated in Site Level condition #003.

IV. RECORDKEEPING REQUIREMENTS.**# 011 [25 Pa. Code §127.511]****Monitoring and related recordkeeping and reporting requirements.**

The permittee shall maintain and record monthly VOC emissions emitted from the facility to demonstrate compliance with Section C, Condition #006.

012 [25 Pa. Code §127.511]**Monitoring and related recordkeeping and reporting requirements.**

The permittee shall maintain a logbook for recording the status of any malodor, visible emission, and/or fugitive emission exceedances. The logbook shall include the name of the company representative, the date and the time the monitoring was conducted, wind direction, and if any malodors, visible emissions, and/or fugitive emissions were detected.

Note: a log entry for each of the above periphery inspections is required whether or not the presence of any odorous emissions, visible emissions, and/or fugitive emissions were detected.

V. REPORTING REQUIREMENTS.**# 013 [25 Pa. Code §127.512]****Operating permit terms and conditions.**

(a) The permittee shall report malfunctions which occur at the facility to the DEP. As defined in 40 CFR Section 60.2 and incorporated by reference in 25 Pa. Code Chapter 122, a malfunction is any sudden, infrequent and not reasonably preventable failure of air pollution control equipment, process equipment, or a process to operate in a normal or usual manner. Failures that are caused in part by poor maintenance or careless operation are not malfunctions. Malfunctions shall be reported as follows:

(1) Any malfunction which poses an imminent danger to the public health, safety, welfare and environment, shall be immediately reported to the DEP by telephone. The telephone report of such malfunctions shall occur no later than two (2) hours after the permittee is aware of the malfunction. The permittee shall submit a written report of instances of such malfunctions to the DEP within three (3) days of the telephone report.

(2) Unless otherwise required by this permit, any other malfunction that is not subject to the reporting requirements of paragraph (1) above, shall be reported to the DEP, in writing, within five (5) days of discovery of the malfunction.

(b) Unless otherwise approved by DEP, all written reports of malfunctions shall be reported to wborst@pa.gov.

(c) Telephone reports can be made to the Reading District Office at 610-916-0100 during normal business hours, or to the Department's Emergency Hotline at any time. The Emergency Hotline phone number is changed/updated periodically. The current Emergency Hotline phone number can be found at:

<https://www.dep.pa.gov/About/Regional/SouthcentralRegion/Pages/default.aspx>.

VI. WORK PRACTICE REQUIREMENTS.**# 014 [25 Pa. Code §123.1]****Prohibition of certain fugitive emissions**

The permittee shall take all reasonable actions to prevent particulate matter from a source identified in Section C, Condition #001 from becoming airborne, as per the §123.1(c). These actions shall include, but are not limited to, the following:



SECTION C. Site Level Requirements

- (a) Use, where possible, of water or chemicals for control of dust in the demolition of buildings or structures, construction operations, the grading of roads, or the clearing of land.
- (b) Application of asphalt, oil, water or suitable chemicals on dirt roads, material stockpiles and other surfaces which may give rise to airborne dusts.
- (c) Paving and maintenance of roadways.
- (d) Prompt removal of earth or other material from paved streets onto which earth or other material has been transported by trucking or earth moving equipment, erosion by water, or other means.

VII. ADDITIONAL REQUIREMENTS.

015 [25 Pa. Code §127.513]

Compliance certification.

The permittee shall submit within thirty days of 01/01/2023 a certificate of compliance with all permit terms and conditions set forth in this Title V permit as required under Condition #024 of Section B of this permit, and annually thereafter. In lieu of a hard copy submittal the permittee shall forward an electronic copy to the DEP SCRO Air Quality Program Manager at wiveaver@pa.gov, unless otherwise directed in writing by DEP.

VIII. COMPLIANCE CERTIFICATION.

No additional compliance certifications exist except as provided in other sections of this permit including Section B (relating to Title V General Requirements).

IX. COMPLIANCE SCHEDULE.

No compliance milestones exist.

***** Permit Shield In Effect *****

**SECTION D. Source Level Requirements**

Source ID: 031

Source Name: AREA HEATERS

Source Capacity/Throughput:	41.000 Gal/HR	PROPANE GAS
	36.000 Gal/HR	OIL NO. 2

Conditions for this source occur in the following groups: GROUP 003

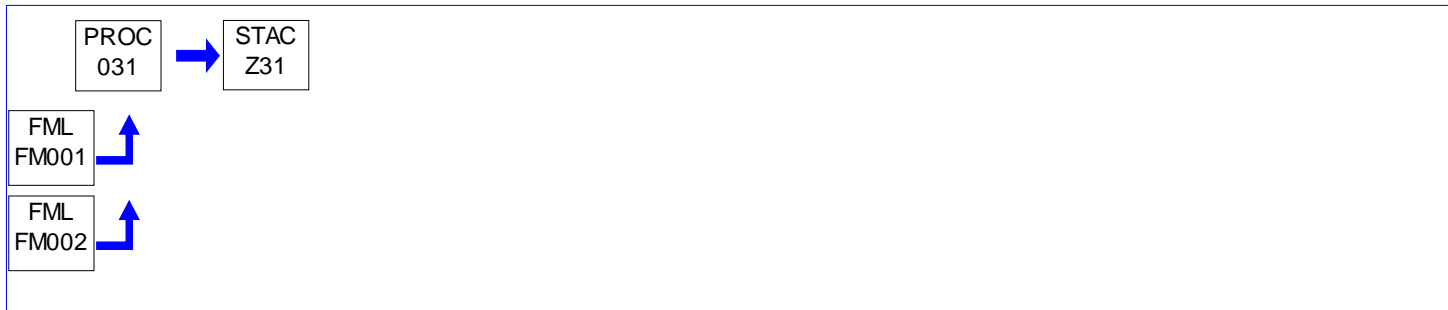
**I. RESTRICTIONS.**

No additional requirements exist except as provided in other sections of this permit including Section B (Title V General Requirements) and/or Section E (Source Group Restrictions).

II. TESTING REQUIREMENTS.

No additional testing requirements exist except as provided in other sections of this permit including Section B (Title V General Requirements) and/or Section E (Source Group Restrictions).

III. MONITORING REQUIREMENTS.

No additional monitoring requirements exist except as provided in other sections of this permit including Section B (Title V General Requirements) and/or Section E (Source Group Restrictions).

IV. RECORDKEEPING REQUIREMENTS.

No additional record keeping requirements exist except as provided in other sections of this permit including Section B (Title V General Requirements) and/or Section E (Source Group Restrictions).

V. REPORTING REQUIREMENTS.

No additional reporting requirements exist except as provided in other sections of this permit including Section B (Title V General Requirements) and/or Section E (Source Group Restrictions).

VI. WORK PRACTICE REQUIREMENTS.

No additional work practice requirements exist except as provided in other sections of this permit including Section B (Title V General Requirements) and/or Section E (Source Group Restrictions).

VII. ADDITIONAL REQUIREMENTS.

No additional requirements exist except as provided in other sections of this permit including Section B (Title V General Requirements) and/or Section E (Source Group Restrictions).

***** Permit Shield in Effect. *****

**SECTION D. Source Level Requirements**

Source ID: 035

Source Name: AIR MAKEUP UNITS 1 THRU 8

Source Capacity/Throughput: 313.980 Gal/HR Propane

**I. RESTRICTIONS.**

No additional requirements exist except as provided in other sections of this permit including Section B (Title V General Requirements).

II. TESTING REQUIREMENTS.

No additional testing requirements exist except as provided in other sections of this permit including Section B (Title V General Requirements).

III. MONITORING REQUIREMENTS.

No additional monitoring requirements exist except as provided in other sections of this permit including Section B (Title V General Requirements).

IV. RECORDKEEPING REQUIREMENTS.

No additional record keeping requirements exist except as provided in other sections of this permit including Section B (Title V General Requirements).

V. REPORTING REQUIREMENTS.

No additional reporting requirements exist except as provided in other sections of this permit including Section B (Title V General Requirements).

VI. WORK PRACTICE REQUIREMENTS.**# 001 [25 Pa. Code §127.441]****Operating permit terms and conditions.**

The permittee shall operate and maintain the Air Makeup Units in accordance with the manufacturer's specifications.

VII. ADDITIONAL REQUIREMENTS.

No additional requirements exist except as provided in other sections of this permit including Section B (Title V General Requirements).

***** Permit Shield in Effect. *****

**SECTION D. Source Level Requirements**

Source ID: 109

Source Name: CWT PARTS WASHER

Source Capacity/Throughput:

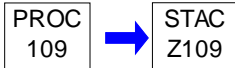
**I. RESTRICTIONS.****Emission Restriction(s).****# 001 [25 Pa. Code §129.63]****Degreasing operations**

The permittee may not use in a cold cleaning machine any solvent with a vapor pressure of 1.0 millimeter of mercury (mm Hg) or greater and containing greater than 5% Volatile Organic Compound (VOC) by weight, measured at 20°C (68°F) containing VOCs. This condition does not apply to the following Cold Cleaning Machines:

- (1) Machines used in extreme cleaning service.
- (2) Machines, in which the Department approves in writing, that compliance with this condition will result in unsafe operating conditions.

II. TESTING REQUIREMENTS.

No additional testing requirements exist except as provided in other sections of this permit including Section B (Title V General Requirements).

III. MONITORING REQUIREMENTS.

No additional monitoring requirements exist except as provided in other sections of this permit including Section B (Title V General Requirements).

IV. RECORDKEEPING REQUIREMENTS.**# 002 [25 Pa. Code §129.63]****Degreasing operations**

The permittee shall maintain for at least two (2) years and shall provide to the Department, on request, the following information:

- (1) The name and address of the solvent supplier.
- (2) The type of solvent including the product or vendor identification number.
- (3) The vapor pressure of the solvent measured in mm hg at 20°C (68°F).

An invoice, bill of sale, certificate that corresponds to a number of sales, Material Safety Data Sheet (MSDS), or other appropriate documentation acceptable to the Department may be used to comply with this section.

V. REPORTING REQUIREMENTS.

No additional reporting requirements exist except as provided in other sections of this permit including Section B (Title V General Requirements).

**SECTION D. Source Level Requirements****VI. WORK PRACTICE REQUIREMENTS.****# 003 [25 Pa. Code §129.63]****Degreasing operations**

(a) The cold cleaning machines shall have a permanent, conspicuous label summarizing the operating requirements in Section D, Condition # 004. In addition, the label shall include the following discretionary good operating practices:

(1) Cleaned parts should be drained at least 15 seconds or until dripping ceases, whichever is longer. Parts having cavities or blind holes shall be tipped or rotated while the part is draining. During the draining, tipping or rotating, the parts should be positioned so that solvent drains directly back to the cold cleaning machine.

(2) When a pump-agitated solvent bath is used, the agitator should be operated to produce a rolling motion of the solvent with no observable splashing of the solvent against the tank walls or the parts being cleaned.

(3) Work area fans should be located and positioned so that they do not blow across the opening of the degreaser unit.

(b) Be equipped with a cover that shall be closed at all times except during cleaning of parts or the addition or removal of solvent. For remote reservoir cold cleaning machines which drain directly into the solvent storage reservoir, a perforated drain with a diameter of not more than six inches shall constitute an acceptable cover.

004 [25 Pa. Code §129.63]**Degreasing operations**

The permittee shall operate the cold cleaning machines in accordance with the following procedures:

(1) Waste solvent shall be collected and stored in closed containers. The closed containers may contain a device that allows pressure relief, but does not allow liquid solvent to drain from the container.

(2) Flushing of parts using a flexible hose or other flushing device shall be performed only within the cold cleaning machine. The solvent spray shall be a solid fluid stream, not an atomized or shower spray.

(3) Sponges, fabric, wood, leather, paper products and other absorbent materials may not be cleaned in the cold cleaning machine.

(4) Air agitated solvent baths may not be used.

(5) Spills during solvent transfer and use of the cold cleaning machine shall be cleaned up immediately.

VII. ADDITIONAL REQUIREMENTS.

No additional requirements exist except as provided in other sections of this permit including Section B (Title V General Requirements).

***** Permit Shield in Effect. *****

**SECTION D. Source Level Requirements**

Source ID: 110

Source Name: PLANT 1 WOODWORKING AREAS 1A & 1B

Source Capacity/Throughput:

Conditions for this source occur in the following groups: GROUP 002

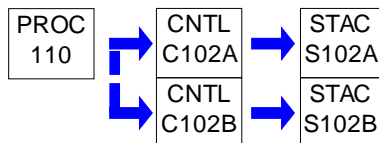
**I. RESTRICTIONS.**

No additional requirements exist except as provided in other sections of this permit including Section B (Title V General Requirements) and/or Section E (Source Group Restrictions).

II. TESTING REQUIREMENTS.

No additional testing requirements exist except as provided in other sections of this permit including Section B (Title V General Requirements) and/or Section E (Source Group Restrictions).

III. MONITORING REQUIREMENTS.

No additional monitoring requirements exist except as provided in other sections of this permit including Section B (Title V General Requirements) and/or Section E (Source Group Restrictions).

IV. RECORDKEEPING REQUIREMENTS.

No additional record keeping requirements exist except as provided in other sections of this permit including Section B (Title V General Requirements) and/or Section E (Source Group Restrictions).

V. REPORTING REQUIREMENTS.

No additional reporting requirements exist except as provided in other sections of this permit including Section B (Title V General Requirements) and/or Section E (Source Group Restrictions).

VI. WORK PRACTICE REQUIREMENTS.

No additional work practice requirements exist except as provided in other sections of this permit including Section B (Title V General Requirements) and/or Section E (Source Group Restrictions).

VII. ADDITIONAL REQUIREMENTS.

No additional requirements exist except as provided in other sections of this permit including Section B (Title V General Requirements) and/or Section E (Source Group Restrictions).

***** Permit Shield in Effect. *****

**SECTION D. Source Level Requirements**

Source ID: 111

Source Name: PLANT 2 WOODWORKING AREAS 2A-2F

Source Capacity/Throughput:

Conditions for this source occur in the following groups: GROUP 002

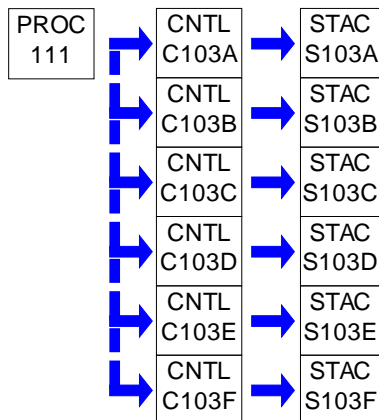
**I. RESTRICTIONS.**

No additional requirements exist except as provided in other sections of this permit including Section B (Title V General Requirements) and/or Section E (Source Group Restrictions).

II. TESTING REQUIREMENTS.

No additional testing requirements exist except as provided in other sections of this permit including Section B (Title V General Requirements) and/or Section E (Source Group Restrictions).

III. MONITORING REQUIREMENTS.

No additional monitoring requirements exist except as provided in other sections of this permit including Section B (Title V General Requirements) and/or Section E (Source Group Restrictions).

IV. RECORDKEEPING REQUIREMENTS.

No additional record keeping requirements exist except as provided in other sections of this permit including Section B (Title V General Requirements) and/or Section E (Source Group Restrictions).

V. REPORTING REQUIREMENTS.

No additional reporting requirements exist except as provided in other sections of this permit including Section B (Title V General Requirements) and/or Section E (Source Group Restrictions).

VI. WORK PRACTICE REQUIREMENTS.

No additional work practice requirements exist except as provided in other sections of this permit including Section B (Title V General Requirements) and/or Section E (Source Group Restrictions).

VII. ADDITIONAL REQUIREMENTS.

No additional requirements exist except as provided in other sections of this permit including Section B (Title V General Requirements) and/or Section E (Source Group Restrictions).



SECTION D. Source Level Requirements

***** Permit Shield in Effect. *****

**SECTION D. Source Level Requirements**

Source ID: 112

Source Name: PLANT 3 WOODWORKING AREAS 3A-3D/3F/3G(5A)

Source Capacity/Throughput:

Conditions for this source occur in the following groups: GROUP 002

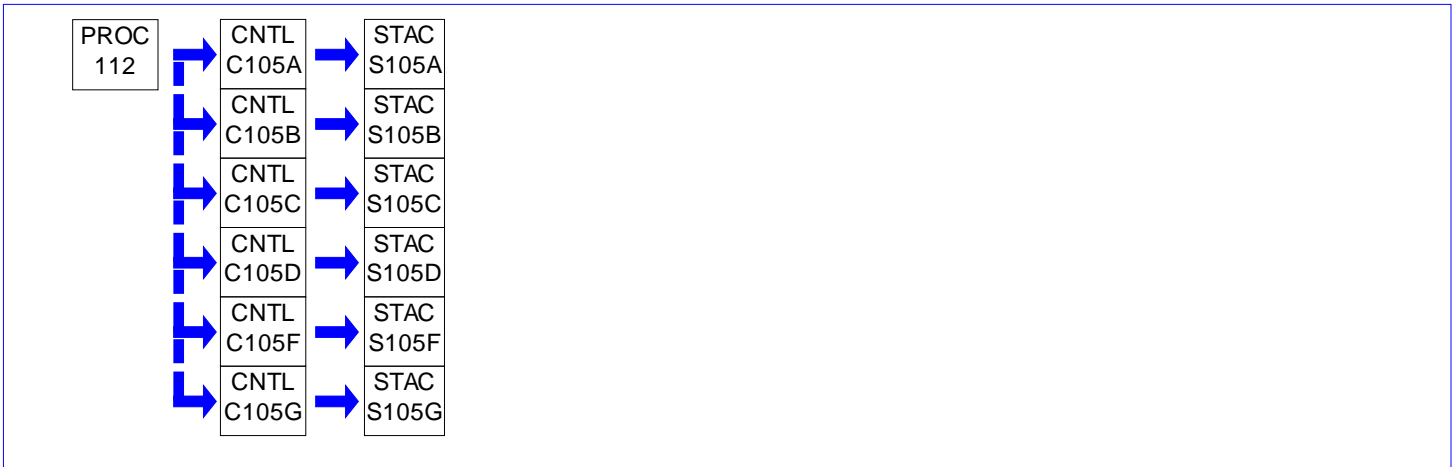
**I. RESTRICTIONS.**

No additional requirements exist except as provided in other sections of this permit including Section B (Title V General Requirements) and/or Section E (Source Group Restrictions).

II. TESTING REQUIREMENTS.

No additional testing requirements exist except as provided in other sections of this permit including Section B (Title V General Requirements) and/or Section E (Source Group Restrictions).

III. MONITORING REQUIREMENTS.

No additional monitoring requirements exist except as provided in other sections of this permit including Section B (Title V General Requirements) and/or Section E (Source Group Restrictions).

IV. RECORDKEEPING REQUIREMENTS.

No additional record keeping requirements exist except as provided in other sections of this permit including Section B (Title V General Requirements) and/or Section E (Source Group Restrictions).

V. REPORTING REQUIREMENTS.

No additional reporting requirements exist except as provided in other sections of this permit including Section B (Title V General Requirements) and/or Section E (Source Group Restrictions).

VI. WORK PRACTICE REQUIREMENTS.

No additional work practice requirements exist except as provided in other sections of this permit including Section B (Title V General Requirements) and/or Section E (Source Group Restrictions).

VII. ADDITIONAL REQUIREMENTS.

No additional requirements exist except as provided in other sections of this permit including Section B (Title V General Requirements) and/or Section E (Source Group Restrictions).



SECTION D. Source Level Requirements

***** Permit Shield in Effect. *****

**SECTION D. Source Level Requirements**

Source ID: 113

Source Name: PLANT 4 WOODWORKING AREAS 4A/4D/4E

Source Capacity/Throughput:

Conditions for this source occur in the following groups: GROUP 002

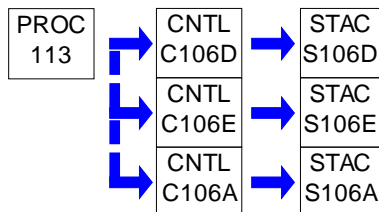
**I. RESTRICTIONS.**

No additional requirements exist except as provided in other sections of this permit including Section B (Title V General Requirements) and/or Section E (Source Group Restrictions).

II. TESTING REQUIREMENTS.

No additional testing requirements exist except as provided in other sections of this permit including Section B (Title V General Requirements) and/or Section E (Source Group Restrictions).

III. MONITORING REQUIREMENTS.

No additional monitoring requirements exist except as provided in other sections of this permit including Section B (Title V General Requirements) and/or Section E (Source Group Restrictions).

IV. RECORDKEEPING REQUIREMENTS.

No additional record keeping requirements exist except as provided in other sections of this permit including Section B (Title V General Requirements) and/or Section E (Source Group Restrictions).

V. REPORTING REQUIREMENTS.

No additional reporting requirements exist except as provided in other sections of this permit including Section B (Title V General Requirements) and/or Section E (Source Group Restrictions).

VI. WORK PRACTICE REQUIREMENTS.

No additional work practice requirements exist except as provided in other sections of this permit including Section B (Title V General Requirements) and/or Section E (Source Group Restrictions).

VII. ADDITIONAL REQUIREMENTS.

No additional requirements exist except as provided in other sections of this permit including Section B (Title V General Requirements) and/or Section E (Source Group Restrictions).

***** Permit Shield in Effect. *****

**SECTION D. Source Level Requirements**

Source ID: 114

Source Name: CUSTOMER SERVICE GENERATOR (CWS3789)

Source Capacity/Throughput:

Conditions for this source occur in the following groups: GROUP 006

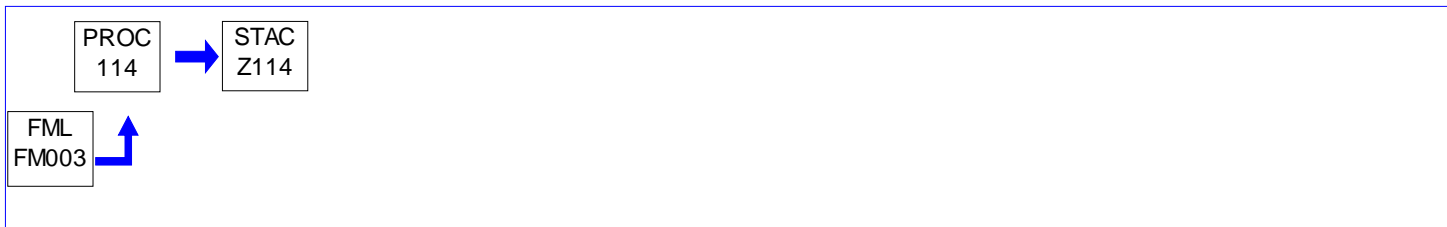
**I. RESTRICTIONS.**

No additional requirements exist except as provided in other sections of this permit including Section B (Title V General Requirements) and/or Section E (Source Group Restrictions).

II. TESTING REQUIREMENTS.

No additional testing requirements exist except as provided in other sections of this permit including Section B (Title V General Requirements) and/or Section E (Source Group Restrictions).

III. MONITORING REQUIREMENTS.

No additional monitoring requirements exist except as provided in other sections of this permit including Section B (Title V General Requirements) and/or Section E (Source Group Restrictions).

IV. RECORDKEEPING REQUIREMENTS.

No additional record keeping requirements exist except as provided in other sections of this permit including Section B (Title V General Requirements) and/or Section E (Source Group Restrictions).

V. REPORTING REQUIREMENTS.

No additional reporting requirements exist except as provided in other sections of this permit including Section B (Title V General Requirements) and/or Section E (Source Group Restrictions).

VI. WORK PRACTICE REQUIREMENTS.

No additional work practice requirements exist except as provided in other sections of this permit including Section B (Title V General Requirements) and/or Section E (Source Group Restrictions).

VII. ADDITIONAL REQUIREMENTS.

No additional requirements exist except as provided in other sections of this permit including Section B (Title V General Requirements) and/or Section E (Source Group Restrictions).

***** Permit Shield in Effect. *****

**SECTION D. Source Level Requirements**

Source ID: 115

Source Name: WAREHOUSE GENERATOR (CWS3770)

Source Capacity/Throughput:

Conditions for this source occur in the following groups: GROUP 006

**I. RESTRICTIONS.**

No additional requirements exist except as provided in other sections of this permit including Section B (Title V General Requirements) and/or Section E (Source Group Restrictions).

II. TESTING REQUIREMENTS.

No additional testing requirements exist except as provided in other sections of this permit including Section B (Title V General Requirements) and/or Section E (Source Group Restrictions).

III. MONITORING REQUIREMENTS.

No additional monitoring requirements exist except as provided in other sections of this permit including Section B (Title V General Requirements) and/or Section E (Source Group Restrictions).

IV. RECORDKEEPING REQUIREMENTS.

No additional record keeping requirements exist except as provided in other sections of this permit including Section B (Title V General Requirements) and/or Section E (Source Group Restrictions).

V. REPORTING REQUIREMENTS.

No additional reporting requirements exist except as provided in other sections of this permit including Section B (Title V General Requirements) and/or Section E (Source Group Restrictions).

VI. WORK PRACTICE REQUIREMENTS.

No additional work practice requirements exist except as provided in other sections of this permit including Section B (Title V General Requirements) and/or Section E (Source Group Restrictions).

VII. ADDITIONAL REQUIREMENTS.

No additional requirements exist except as provided in other sections of this permit including Section B (Title V General Requirements) and/or Section E (Source Group Restrictions).

***** Permit Shield in Effect. *****

**SECTION D. Source Level Requirements**

Source ID: 116

Source Name: PLANT 1 & 2 EMERGENCY GENERATOR (CWS3423)

Source Capacity/Throughput:

Conditions for this source occur in the following groups: GROUP 007

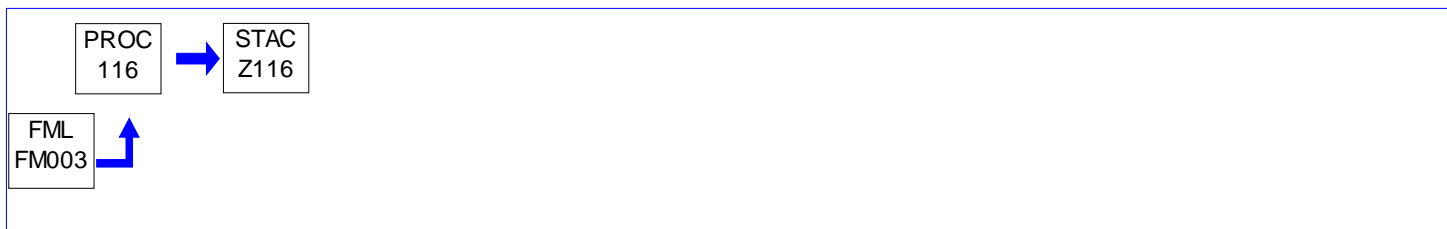
**I. RESTRICTIONS.**

No additional requirements exist except as provided in other sections of this permit including Section B (Title V General Requirements) and/or Section E (Source Group Restrictions).

II. TESTING REQUIREMENTS.

No additional testing requirements exist except as provided in other sections of this permit including Section B (Title V General Requirements) and/or Section E (Source Group Restrictions).

III. MONITORING REQUIREMENTS.

No additional monitoring requirements exist except as provided in other sections of this permit including Section B (Title V General Requirements) and/or Section E (Source Group Restrictions).

IV. RECORDKEEPING REQUIREMENTS.

No additional record keeping requirements exist except as provided in other sections of this permit including Section B (Title V General Requirements) and/or Section E (Source Group Restrictions).

V. REPORTING REQUIREMENTS.

No additional reporting requirements exist except as provided in other sections of this permit including Section B (Title V General Requirements) and/or Section E (Source Group Restrictions).

VI. WORK PRACTICE REQUIREMENTS.

No additional work practice requirements exist except as provided in other sections of this permit including Section B (Title V General Requirements) and/or Section E (Source Group Restrictions).

VII. ADDITIONAL REQUIREMENTS.

No additional requirements exist except as provided in other sections of this permit including Section B (Title V General Requirements) and/or Section E (Source Group Restrictions).

***** Permit Shield in Effect. *****

**SECTION D. Source Level Requirements**

Source ID: 121

Source Name: FIRE PUMP ENGINE (CWS251)

Source Capacity/Throughput:

Conditions for this source occur in the following groups: GROUP 007

**I. RESTRICTIONS.****Emission Restriction(s).****# 001 [25 Pa. Code §129.97]****Presumptive RACT requirements, RACT emission limitations and petition for alternative compliance schedule.**

The permittee shall operate and maintain the above fire pump engine in accordance with the manufacturer's specifications and with good operating practices

II. TESTING REQUIREMENTS.

No additional testing requirements exist except as provided in other sections of this permit including Section B (Title V General Requirements) and/or Section E (Source Group Restrictions).

III. MONITORING REQUIREMENTS.

No additional monitoring requirements exist except as provided in other sections of this permit including Section B (Title V General Requirements) and/or Section E (Source Group Restrictions).

IV. RECORDKEEPING REQUIREMENTS.**# 002 [25 Pa. Code §129.100]****Compliance demonstration and recordkeeping requirements.**

All records shall be retained by the owner or operator for 5 years and made available to the DEP or appropriate approved local air pollution control agency upon receipt of a written request from the DEP or appropriate approved local air pollution control agency.

V. REPORTING REQUIREMENTS.

No additional reporting requirements exist except as provided in other sections of this permit including Section B (Title V General Requirements) and/or Section E (Source Group Restrictions).

VI. WORK PRACTICE REQUIREMENTS.

No additional work practice requirements exist except as provided in other sections of this permit including Section B (Title V General Requirements) and/or Section E (Source Group Restrictions).

VII. ADDITIONAL REQUIREMENTS.

No additional requirements exist except as provided in other sections of this permit including Section B (Title V General Requirements) and/or Section E (Source Group Restrictions).

***** Permit Shield in Effect. *****

**SECTION D. Source Level Requirements**

Source ID: 122

Source Name: PLANT #7 GENERATOR (CWS4073)

Source Capacity/Throughput:

Conditions for this source occur in the following groups: GROUP 002
GROUP 006

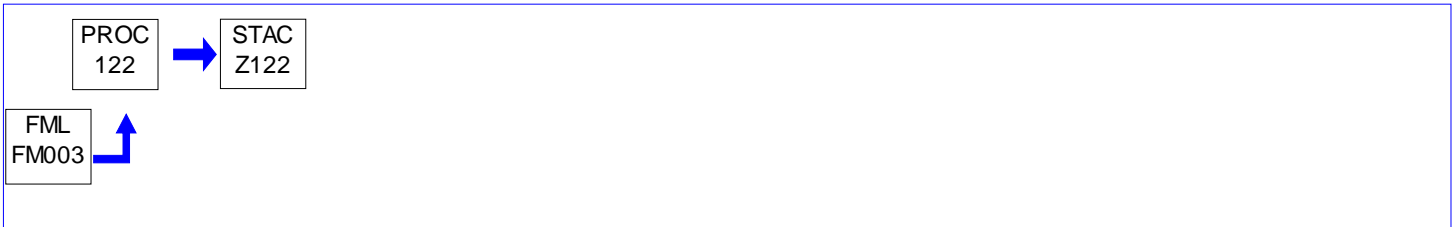
**I. RESTRICTIONS.**

No additional requirements exist except as provided in other sections of this permit including Section B (Title V General Requirements) and/or Section E (Source Group Restrictions).

II. TESTING REQUIREMENTS.

No additional testing requirements exist except as provided in other sections of this permit including Section B (Title V General Requirements) and/or Section E (Source Group Restrictions).

III. MONITORING REQUIREMENTS.

No additional monitoring requirements exist except as provided in other sections of this permit including Section B (Title V General Requirements) and/or Section E (Source Group Restrictions).

IV. RECORDKEEPING REQUIREMENTS.

No additional record keeping requirements exist except as provided in other sections of this permit including Section B (Title V General Requirements) and/or Section E (Source Group Restrictions).

V. REPORTING REQUIREMENTS.

No additional reporting requirements exist except as provided in other sections of this permit including Section B (Title V General Requirements) and/or Section E (Source Group Restrictions).

VI. WORK PRACTICE REQUIREMENTS.

No additional work practice requirements exist except as provided in other sections of this permit including Section B (Title V General Requirements) and/or Section E (Source Group Restrictions).

VII. ADDITIONAL REQUIREMENTS.

No additional requirements exist except as provided in other sections of this permit including Section B (Title V General Requirements) and/or Section E (Source Group Restrictions).

***** Permit Shield in Effect. *****

**SECTION D. Source Level Requirements**

Source ID: 123

Source Name: NOC GENERATOR (CWS4547)

Source Capacity/Throughput:

Conditions for this source occur in the following groups: GROUP 008

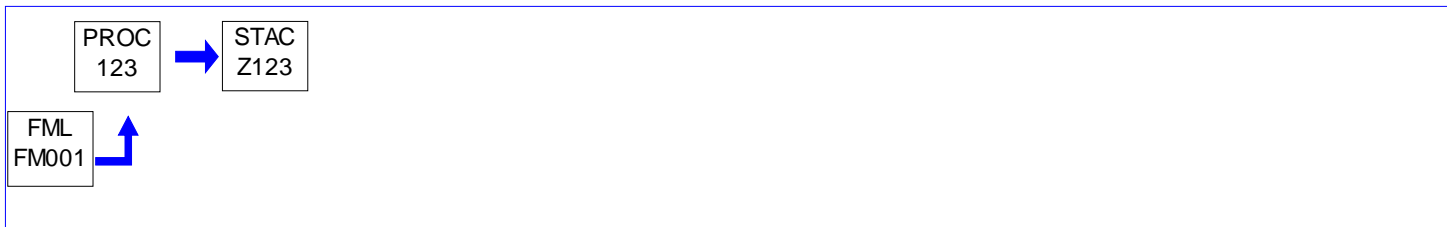
**I. RESTRICTIONS.**

No additional requirements exist except as provided in other sections of this permit including Section B (Title V General Requirements) and/or Section E (Source Group Restrictions).

II. TESTING REQUIREMENTS.

No additional testing requirements exist except as provided in other sections of this permit including Section B (Title V General Requirements) and/or Section E (Source Group Restrictions).

III. MONITORING REQUIREMENTS.

No additional monitoring requirements exist except as provided in other sections of this permit including Section B (Title V General Requirements) and/or Section E (Source Group Restrictions).

IV. RECORDKEEPING REQUIREMENTS.

No additional record keeping requirements exist except as provided in other sections of this permit including Section B (Title V General Requirements) and/or Section E (Source Group Restrictions).

V. REPORTING REQUIREMENTS.

No additional reporting requirements exist except as provided in other sections of this permit including Section B (Title V General Requirements) and/or Section E (Source Group Restrictions).

VI. WORK PRACTICE REQUIREMENTS.

No additional work practice requirements exist except as provided in other sections of this permit including Section B (Title V General Requirements) and/or Section E (Source Group Restrictions).

VII. ADDITIONAL REQUIREMENTS.

No additional requirements exist except as provided in other sections of this permit including Section B (Title V General Requirements) and/or Section E (Source Group Restrictions).

***** Permit Shield in Effect. *****



SECTION D. Source Level Requirements

Source ID: 201

Source Name: PLANT 5 SPRAY BOOTHS

Source Capacity/Throughput:

Conditions for this source occur in the following groups: GROUP 001
GROUP 005

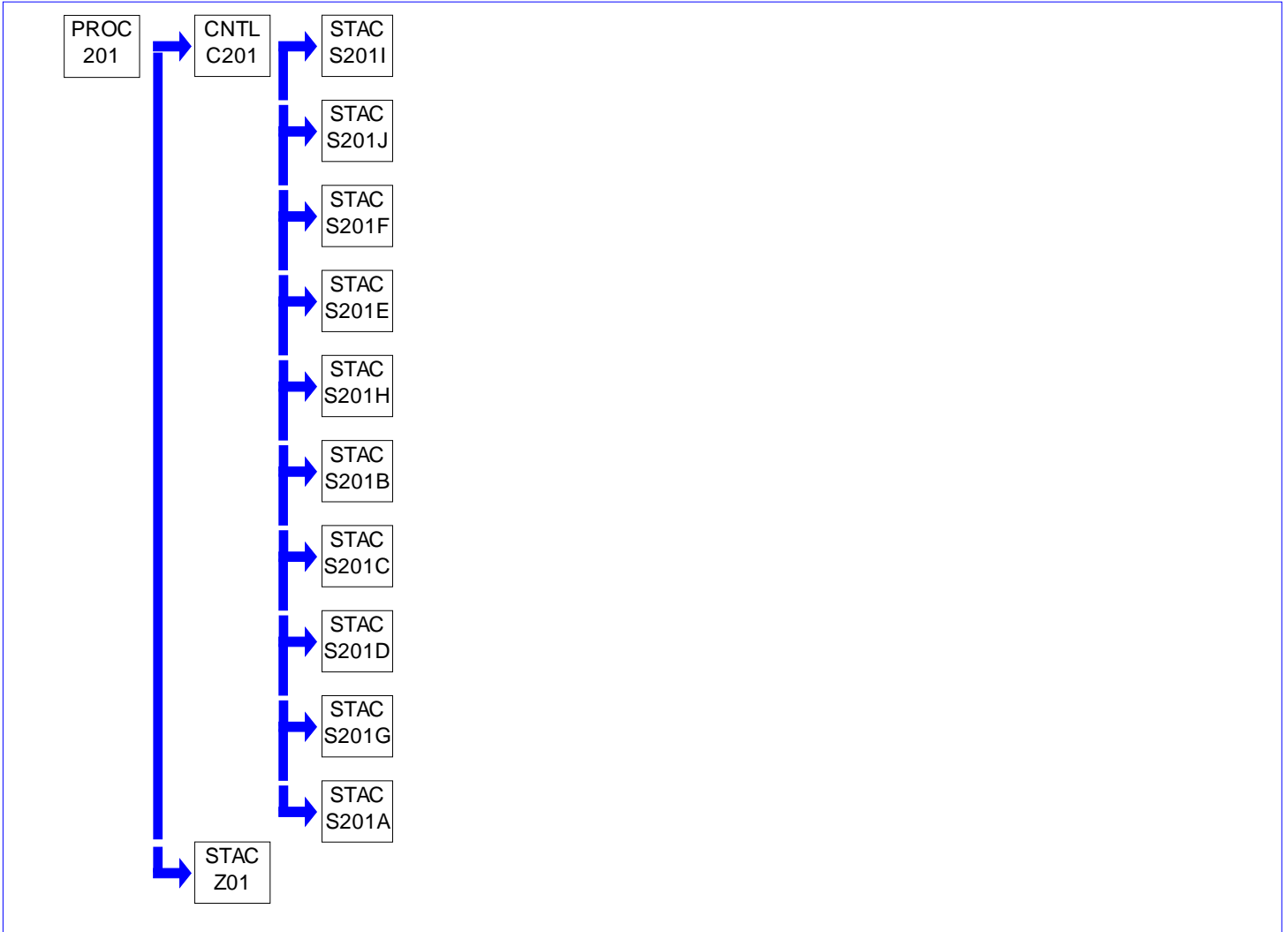

I. RESTRICTIONS.

No additional requirements exist except as provided in other sections of this permit including Section B (Title V General Requirements) and/or Section E (Source Group Restrictions).

II. TESTING REQUIREMENTS.

No additional testing requirements exist except as provided in other sections of this permit including Section B (Title V General Requirements) and/or Section E (Source Group Restrictions).

III. MONITORING REQUIREMENTS.

No additional monitoring requirements exist except as provided in other sections of this permit including Section B (Title V General Requirements) and/or Section E (Source Group Restrictions).



SECTION D. Source Level Requirements

IV. RECORDKEEPING REQUIREMENTS.

No additional record keeping requirements exist except as provided in other sections of this permit including Section B (Title V General Requirements) and/or Section E (Source Group Restrictions).

V. REPORTING REQUIREMENTS.

No additional reporting requirements exist except as provided in other sections of this permit including Section B (Title V General Requirements) and/or Section E (Source Group Restrictions).

VI. WORK PRACTICE REQUIREMENTS.

No additional work practice requirements exist except as provided in other sections of this permit including Section B (Title V General Requirements) and/or Section E (Source Group Restrictions).

VII. ADDITIONAL REQUIREMENTS.

No additional requirements exist except as provided in other sections of this permit including Section B (Title V General Requirements) and/or Section E (Source Group Restrictions).

***** Permit Shield in Effect. *****

**SECTION D. Source Level Requirements**

Source ID: 202

Source Name: PLANT 7 SPRAY BOOTHS

Source Capacity/Throughput:

Conditions for this source occur in the following groups: GROUP 001
GROUP 005

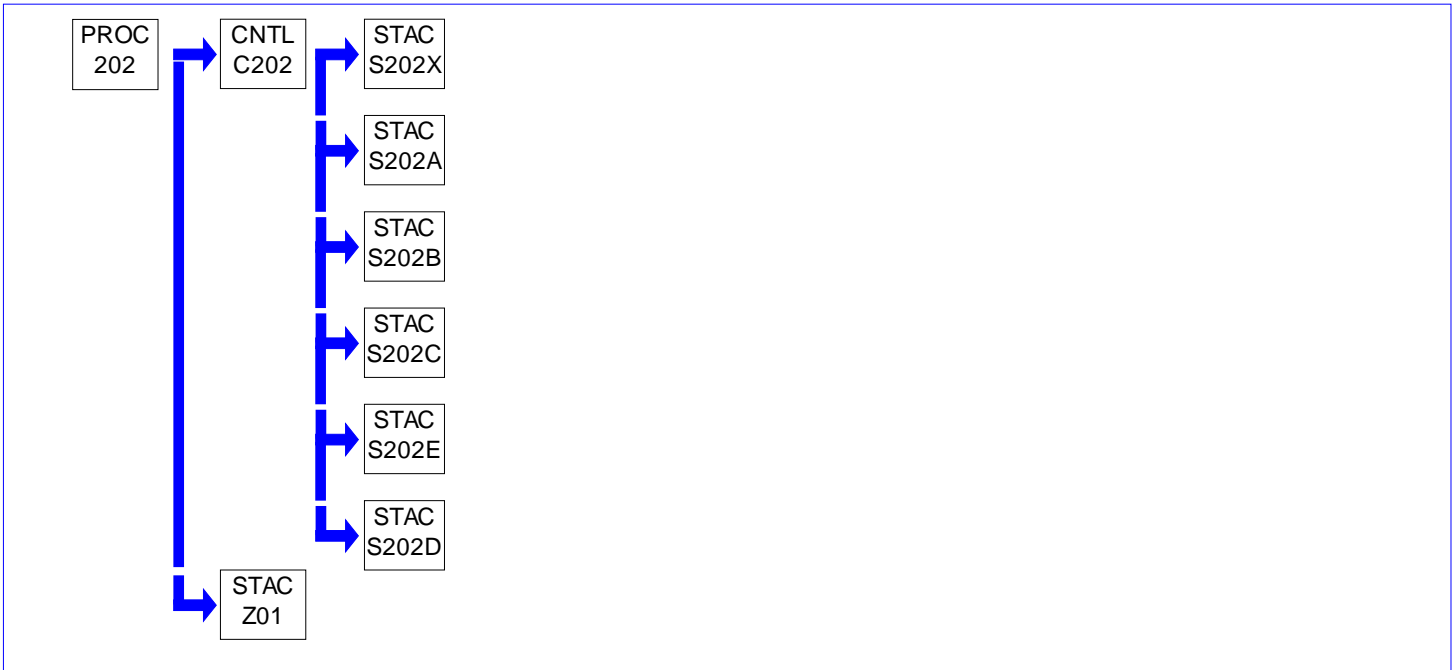
**I. RESTRICTIONS.**

No additional requirements exist except as provided in other sections of this permit including Section B (Title V General Requirements) and/or Section E (Source Group Restrictions).

II. TESTING REQUIREMENTS.

No additional testing requirements exist except as provided in other sections of this permit including Section B (Title V General Requirements) and/or Section E (Source Group Restrictions).

III. MONITORING REQUIREMENTS.

No additional monitoring requirements exist except as provided in other sections of this permit including Section B (Title V General Requirements) and/or Section E (Source Group Restrictions).

IV. RECORDKEEPING REQUIREMENTS.

No additional record keeping requirements exist except as provided in other sections of this permit including Section B (Title V General Requirements) and/or Section E (Source Group Restrictions).

V. REPORTING REQUIREMENTS.

No additional reporting requirements exist except as provided in other sections of this permit including Section B (Title V General Requirements) and/or Section E (Source Group Restrictions).

**SECTION D. Source Level Requirements****VI. WORK PRACTICE REQUIREMENTS.**

No additional work practice requirements exist except as provided in other sections of this permit including Section B (Title V General Requirements) and/or Section E (Source Group Restrictions).

VII. ADDITIONAL REQUIREMENTS.

No additional requirements exist except as provided in other sections of this permit including Section B (Title V General Requirements) and/or Section E (Source Group Restrictions).

***** Permit Shield in Effect. *****

**SECTION D. Source Level Requirements**

Source ID: 205

Source Name: LAB COAT SPRAY BOOTH

Source Capacity/Throughput:

Conditions for this source occur in the following groups: GROUP 001

GROUP 005

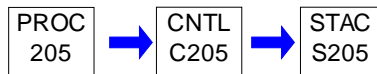
**I. RESTRICTIONS.**

No additional requirements exist except as provided in other sections of this permit including Section B (Title V General Requirements) and/or Section E (Source Group Restrictions).

II. TESTING REQUIREMENTS.

No additional testing requirements exist except as provided in other sections of this permit including Section B (Title V General Requirements) and/or Section E (Source Group Restrictions).

III. MONITORING REQUIREMENTS.

No additional monitoring requirements exist except as provided in other sections of this permit including Section B (Title V General Requirements) and/or Section E (Source Group Restrictions).

IV. RECORDKEEPING REQUIREMENTS.

No additional record keeping requirements exist except as provided in other sections of this permit including Section B (Title V General Requirements) and/or Section E (Source Group Restrictions).

V. REPORTING REQUIREMENTS.

No additional reporting requirements exist except as provided in other sections of this permit including Section B (Title V General Requirements) and/or Section E (Source Group Restrictions).

VI. WORK PRACTICE REQUIREMENTS.

No additional work practice requirements exist except as provided in other sections of this permit including Section B (Title V General Requirements) and/or Section E (Source Group Restrictions).

VII. ADDITIONAL REQUIREMENTS.

No additional requirements exist except as provided in other sections of this permit including Section B (Title V General Requirements) and/or Section E (Source Group Restrictions).

***** Permit Shield in Effect. *****

**SECTION D. Source Level Requirements**

Source ID: 206

Source Name: RECIPROCATING SPRAY LINE/OVENS VENJAKOB NO. 1

Source Capacity/Throughput:

Conditions for this source occur in the following groups: GROUP 001

GROUP 005

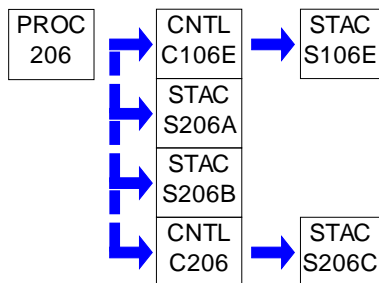
**I. RESTRICTIONS.****Emission Restriction(s).****# 001 [25 Pa. Code §127.441]****Operating permit terms and conditions.**

The volatile organic compound (VOC) emissions, associated with the operations of the above source, shall not exceed 30 tpy based on a consecutive 12-month rolling period.

II. TESTING REQUIREMENTS.**# 002 [25 Pa. Code §127.441]****Operating permit terms and conditions.**

The permittee may demonstrate compliance with the VHAP/VOC content limitations of 40 CFR Part 63, Subpart JJ by one of the following:

(a) EPA Reference Test Methods 24 and 311.

(b) Calculated VHAP/VOC content values may be used in lieu of Test Methods 24 and 311 for customized coatings where the permittee maintains a Certified Product Data Sheet (CPDS) for all coating constituents (i.e., coatings, pigments, thinners, etc.); this option is available in those cases where both the base coating and the final customized coating meet the VHAP/VOC content limitations of 40 CFR Part 63, Subpart JJ.

(c) In the event of any inconsistency between the calculated VHAP/VOC content and data obtained from a Method 24 or 311 analysis, the analytical data shall take precedence.

III. MONITORING REQUIREMENTS.

No additional monitoring requirements exist except as provided in other sections of this permit including Section B (Title V General Requirements) and/or Section E (Source Group Restrictions).

IV. RECORDKEEPING REQUIREMENTS.**# 003 [25 Pa. Code §127.441]****Operating permit terms and conditions.**

The permittee shall maintain records of all EPA Method 24 certification testing performed for the most recent five year period. The records shall be made available to the Department's representative upon request.

**SECTION D. Source Level Requirements****V. REPORTING REQUIREMENTS.****# 004 [25 Pa. Code §127.441]****Operating permit terms and conditions.**

Annual VOC emission report shall be submitted to the Air Quality District Supervisor. The report for January 1 through December 31 is due no later than March 1 of the following year for each operating year authorized by the operating permit or its renewal. Each report shall include the following information:

- (a) Line designation (Spray or UV/Rollcoat)
- (b) Coating identification
- (c) Coating use (e.g., sealer)
- (d) Pound of VOC per pound solid, as applied
- (e) Coating density, lb/gal
- (f) Percent VOC by weight
- (g) Percent solids (by volume)
- (h) Percent solids (by weight)
- (i) Percent water (by volume)
- (j) Monthly totals, in gallons, of each coating used
- (k) Type, VOC content and monthly totals of cleanup solvent utilized
- (l) Monthly facility VOC emissions, and
- (m) Monthly HAP emissions.

VI. WORK PRACTICE REQUIREMENTS.

No additional work practice requirements exist except as provided in other sections of this permit including Section B (Title V General Requirements) and/or Section E (Source Group Restrictions).

VII. ADDITIONAL REQUIREMENTS.**# 005 [25 Pa. Code §127.441]****Operating permit terms and conditions.**

Should credit be desired for those waste coatings or solvents sent off-site for either recycling or incineration at a legally permitted facility, the following information will be required:

- (a) The quantities being disposed of
- (b) VOC content of the waste coatings or solvents being disposed of, and
- (c) Documentation to verify the above.

***** Permit Shield in Effect. *****

**SECTION D. Source Level Requirements**

Source ID: 207

Source Name: RECIPROCATING SPRAY LINE/OVENS VENJAKOB NO. 2

Source Capacity/Throughput:

Conditions for this source occur in the following groups: GROUP 001
GROUP 005

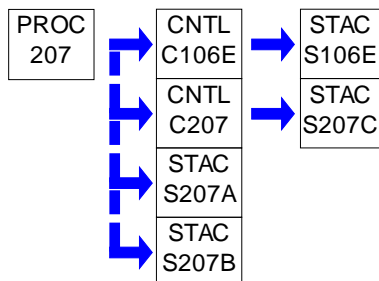
**I. RESTRICTIONS.**

No additional requirements exist except as provided in other sections of this permit including Section B (Title V General Requirements) and/or Section E (Source Group Restrictions).

II. TESTING REQUIREMENTS.

No additional testing requirements exist except as provided in other sections of this permit including Section B (Title V General Requirements) and/or Section E (Source Group Restrictions).

III. MONITORING REQUIREMENTS.

No additional monitoring requirements exist except as provided in other sections of this permit including Section B (Title V General Requirements) and/or Section E (Source Group Restrictions).

IV. RECORDKEEPING REQUIREMENTS.

No additional record keeping requirements exist except as provided in other sections of this permit including Section B (Title V General Requirements) and/or Section E (Source Group Restrictions).

V. REPORTING REQUIREMENTS.

No additional reporting requirements exist except as provided in other sections of this permit including Section B (Title V General Requirements) and/or Section E (Source Group Restrictions).

VI. WORK PRACTICE REQUIREMENTS.

No additional work practice requirements exist except as provided in other sections of this permit including Section B (Title V General Requirements) and/or Section E (Source Group Restrictions).

VII. ADDITIONAL REQUIREMENTS.

No additional requirements exist except as provided in other sections of this permit including Section B (Title V General Requirements) and/or Section E (Source Group Restrictions).

***** Permit Shield in Effect. *****

**SECTION D. Source Level Requirements**

Source ID: 208

Source Name: RECIPROCATING SPRAY LINE/OVENS VENJAKOB NO. 3

Source Capacity/Throughput:

Conditions for this source occur in the following groups: GROUP 001
GROUP 005

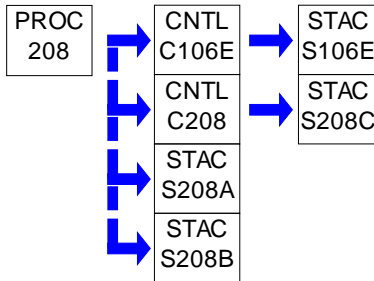
**I. RESTRICTIONS.**

No additional requirements exist except as provided in other sections of this permit including Section B (Title V General Requirements) and/or Section E (Source Group Restrictions).

II. TESTING REQUIREMENTS.

No additional testing requirements exist except as provided in other sections of this permit including Section B (Title V General Requirements) and/or Section E (Source Group Restrictions).

III. MONITORING REQUIREMENTS.

No additional monitoring requirements exist except as provided in other sections of this permit including Section B (Title V General Requirements) and/or Section E (Source Group Restrictions).

IV. RECORDKEEPING REQUIREMENTS.

No additional record keeping requirements exist except as provided in other sections of this permit including Section B (Title V General Requirements) and/or Section E (Source Group Restrictions).

V. REPORTING REQUIREMENTS.

No additional reporting requirements exist except as provided in other sections of this permit including Section B (Title V General Requirements) and/or Section E (Source Group Restrictions).

VI. WORK PRACTICE REQUIREMENTS.

No additional work practice requirements exist except as provided in other sections of this permit including Section B (Title V General Requirements) and/or Section E (Source Group Restrictions).

VII. ADDITIONAL REQUIREMENTS.

No additional requirements exist except as provided in other sections of this permit including Section B (Title V General Requirements) and/or Section E (Source Group Restrictions).

***** Permit Shield in Effect. *****

**SECTION D. Source Level Requirements**

Source ID: 221

Source Name: SHAVING STORAGE BIN 1, PLANT 1

Source Capacity/Throughput:

Conditions for this source occur in the following groups: GROUP 002

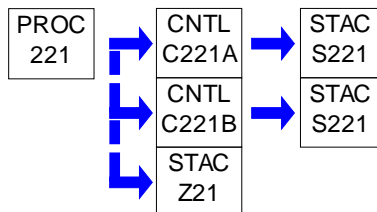
**I. RESTRICTIONS.**

No additional requirements exist except as provided in other sections of this permit including Section B (Title V General Requirements) and/or Section E (Source Group Restrictions).

II. TESTING REQUIREMENTS.

No additional testing requirements exist except as provided in other sections of this permit including Section B (Title V General Requirements) and/or Section E (Source Group Restrictions).

III. MONITORING REQUIREMENTS.

No additional monitoring requirements exist except as provided in other sections of this permit including Section B (Title V General Requirements) and/or Section E (Source Group Restrictions).

IV. RECORDKEEPING REQUIREMENTS.

No additional record keeping requirements exist except as provided in other sections of this permit including Section B (Title V General Requirements) and/or Section E (Source Group Restrictions).

V. REPORTING REQUIREMENTS.

No additional reporting requirements exist except as provided in other sections of this permit including Section B (Title V General Requirements) and/or Section E (Source Group Restrictions).

VI. WORK PRACTICE REQUIREMENTS.

No additional work practice requirements exist except as provided in other sections of this permit including Section B (Title V General Requirements) and/or Section E (Source Group Restrictions).

VII. ADDITIONAL REQUIREMENTS.

No additional requirements exist except as provided in other sections of this permit including Section B (Title V General Requirements) and/or Section E (Source Group Restrictions).

***** Permit Shield in Effect. *****

**SECTION D. Source Level Requirements**

Source ID: 222

Source Name: SHAVING STORAGE BIN 2, PLANT 3

Source Capacity/Throughput:

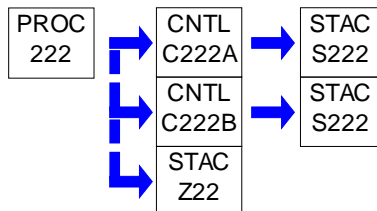
**I. RESTRICTIONS.**

No additional requirements exist except as provided in other sections of this permit including Section B (Title V General Requirements).

II. TESTING REQUIREMENTS.

No additional testing requirements exist except as provided in other sections of this permit including Section B (Title V General Requirements).

III. MONITORING REQUIREMENTS.

No additional monitoring requirements exist except as provided in other sections of this permit including Section B (Title V General Requirements).

IV. RECORDKEEPING REQUIREMENTS.

No additional record keeping requirements exist except as provided in other sections of this permit including Section B (Title V General Requirements).

V. REPORTING REQUIREMENTS.

No additional reporting requirements exist except as provided in other sections of this permit including Section B (Title V General Requirements).

VI. WORK PRACTICE REQUIREMENTS.

No additional work practice requirements exist except as provided in other sections of this permit including Section B (Title V General Requirements).

VII. ADDITIONAL REQUIREMENTS.

No additional requirements exist except as provided in other sections of this permit including Section B (Title V General Requirements).

***** Permit Shield in Effect. *****

**SECTION D. Source Level Requirements**

Source ID: 610C

Source Name: GASOLINE STORAGE TANK, 5000 GAL UG

Source Capacity/Throughput:

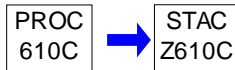
**I. RESTRICTIONS.**

No additional requirements exist except as provided in other sections of this permit including Section B (Title V General Requirements).

II. TESTING REQUIREMENTS.

No additional testing requirements exist except as provided in other sections of this permit including Section B (Title V General Requirements).

III. MONITORING REQUIREMENTS.

No additional monitoring requirements exist except as provided in other sections of this permit including Section B (Title V General Requirements).

IV. RECORDKEEPING REQUIREMENTS.

No additional record keeping requirements exist except as provided in other sections of this permit including Section B (Title V General Requirements).

V. REPORTING REQUIREMENTS.

No additional reporting requirements exist except as provided in other sections of this permit including Section B (Title V General Requirements).

VI. WORK PRACTICE REQUIREMENTS.**# 001 [25 Pa. Code §129.57]****Storage tanks less than or equal to 40,000 gallons capacity containing VOCs**

Storage tanks containing a volatile organic compound with a vapor pressure greater than 1.5 psia in quantities between 2,000 and 40,000 gallons shall be equipped with pressure relief valves set to release at no less than 0.7 psig pressure or 0.3 psig vacuum or the highest possible pressure and vacuum in accordance with state or local fire codes or the National Fire Prevention Association guidelines or other national consensus standards acceptable to the Department. For volatile organic compounds whose storage temperature is governed by ambient weather conditions, the vapor pressure under actual storage conditions shall be determined using a temperature which is representative of the average storage temperature for the hottest month of the year in which the storage takes place.

VII. ADDITIONAL REQUIREMENTS.

No additional requirements exist except as provided in other sections of this permit including Section B (Title V General Requirements).

***** Permit Shield in Effect. *****

**SECTION E. Source Group Restrictions.**

Group Name: GROUP 001

Group Description: 40 CFR Part 63, Subpart JJ Requirements

Sources included in this group

ID	Name
201	PLANT 5 SPRAY BOOTHS
202	PLANT 7 SPRAY BOOTHS
205	LAB COAT SPRAY BOOTH
206	RECIPROCATING SPRAY LINE/OVENS VENJAKOB NO. 1
207	RECIPROCATING SPRAY LINE/OVENS VENJAKOB NO. 2
208	RECIPROCATING SPRAY LINE/OVENS VENJAKOB NO. 3

I. RESTRICTIONS.**Emission Restriction(s).****# 001 [40 CFR Part 63 NESHAPS for Source Categories §40 CFR 63.800]****Subpart JJ--National Emission Standards for Wood Furniture Manufacturing Operations Applicability.**

§63.800 Applicability.

(a) The affected source to which this subpart applies is each facility that is engaged, either in part or in whole, in the manufacture of wood furniture or wood furniture components and that is located at a plant site that is a major source as defined in 40 CFR part 63, subpart A, §63.2. The owner or operator of a source that meets the definition for an incidental wood furniture manufacturer shall maintain purchase or usage records demonstrating that the source meets the definition in §63.801 of this subpart, but the source shall not be subject to any other provisions of this subpart.

(b) [NA - NOT AN AREA SOURCE]

(c) This subpart does not apply to research or laboratory facilities as defined in §63.801.

(d) [NA - NONE OF THE LISTED EXEMPTIONS APPLY]

(e) Owners or operators of affected sources shall also comply with the requirements of subpart A of this part (General Provisions), according to the applicability of subpart A to such sources, as identified in Table 1 of this subpart.

(f) The compliance date for existing affected sources that emit less than 50 tons per year of HAP in 1996 is December 7, 1998. The compliance date for existing affected sources that emit 50 tons or more of hazardous air pollutants in 1996 is November 21, 1997. The owner or operator of an existing area source that increases its emissions of (or its potential to emit) HAP such that the source becomes a major source that is subject to this subpart shall comply with this subpart one year after becoming a major source.

(g) Existing affected sources shall be in compliance with §63.802(a)(4) and §63.803(h) no later than November 21, 2014. The owner or operator of an existing area source that increases its emissions of (or its potential to emit) hazardous air pollutants (HAP) such that the source becomes a major source that is subject to this subpart shall comply with this subpart 1 year after becoming a major source.

(h) New affected sources must comply with the provisions of this standard immediately upon startup or by December 7, 1995, whichever is later. New area sources that become major sources shall comply with the provisions of this standard immediately upon becoming a major source.

(i) [NA - FACILITY IS NOT RECONSTRUCTED]

(j) [NA - NO ADD-ON CONTROLS]

[60 FR 62936, Dec. 7, 1995, as amended at 62 FR 30259, June 3, 1997; 76 FR 72071, Nov. 21, 2011]

§63.801 Definitions. [INCORPORATED BY REFERENCE]

**SECTION E. Source Group Restrictions.**

§63.802 Emission limits.

(a) Each owner or operator of an existing affected source subject to this subpart shall:

(1) Limit VHAP emissions from finishing operations by meeting the emission limitations for existing sources presented in Table 3 of this subpart, using any of the compliance methods in §63.804(a). To determine VHAP emissions from a finishing material containing formaldehyde or styrene, the owner or operator of the affected source shall use the methods presented in §63.803(l)(2) for determining styrene and formaldehyde usage.

TABLE 3 REQUIREMENTS:

Emission Point: Finishing Operations:

(a) Achieve a weighted average VHAP content across all coatings (maximum kg VHAP/kg solids [lb VHAP/lb solids], as applied, of 1.0*, for an existing affected source.

(b) Use compliant finishing materials (maximum kg VHAP/kg solids [lb VHAP/lb solids], as applied), as follows, for an existing source:

Stains: 1.0*

Washcoats: 1.0*#

Sealers: 1.0*

Topcoats: 1.0*

Basecoats: 1.0*#

Enamels: 1.0*#

Thinners (maximum percent VHAP allowable) : 10.0

Emission Point: Cleaning Operations: Strippable spray booth material (maximum VOC content, kg VOC/kg solids [lb VOC/lb solids]): 0.8

Emission Point: Contact Adhesives:

(a) Use compliant contact adhesives (maximum kg VHAP/kg solids [lb VHAP/lb solids], as applied) based on following criteria:

i. For aerosol adhesives, and for contact adhesives applied to nonporous substrates: NA@

ii. For foam adhesives used in products that meet flammability requirements, for an existing source: 1.8

iii. For all other contact adhesives (including foam adhesives used in products that do not meet flammability requirements), for an existing source: 1.0

Emission Point: All Finishing Operations and Contact Adhesives:

(a) Achieve total free formaldehyde emissions across all finishing operations and contact adhesives, lb per rolling 12 month period, as applied: 400

(b) Use coatings and contact adhesives only if they are low-formaldehyde coatings and contact adhesives: 1.0^

*The limits refer to the VHAP content of the coating, as applied.

#Washcoats, basecoats, and enamels must comply with the limits presented in this table if they are purchased premade, that is, if they are not formulated onsite by thinning other finishing materials. If they are formulated onsite, they must be formulated using compliant finishing materials, i.e., those that meet the limits specified in this table, and thinners containing no more than 3.0 percent VHAP by weight.

@There is no limit on the VHAP content of these adhesives.

**SECTION E. Source Group Restrictions.**

[^]The limits refer to the formaldehyde content by weight of the coating or contact adhesive, as specified on certified product data sheets.

[60 FR 62936, Dec. 7, 1995, as amended at 62 FR 30260, June 3, 1997; 76 FR 72073, Nov. 21, 2011]

END OF TABLE 3 REQUIREMENTS

(2) Limit VHAP emissions from contact adhesives by achieving a VHAP limit for contact adhesives based on the following criteria:

(i) For foam adhesives (contact adhesives used for upholstery operations) used in products that meet the upholstered seating flammability requirements of California Technical Bulletin 116, 117, or 133, the Business and Institutional Furniture Manufacturers Association's (BIFMA's) X5.7, UFAC flammability testing, or any similar requirements from local, State, or Federal fire regulatory agencies, the VHAP content of the adhesive shall not exceed 1.8 kg VHAP/kg solids (1.8 lb VHAP/lb solids), as applied; or

(ii) For all other contact adhesives (including foam adhesives used in products that do not meet the standards presented in paragraph (a)(2)(i) of this section, but excluding aerosol adhesives and excluding contact adhesives applied to nonporous substrates, the VHAP content of the adhesive shall not exceed 1.0 kg VHAP/kg solids (1.0 lb VHAP/lb solids), as applied.

(3) Limit HAP emissions from strippable spray booth coatings by using coatings that contain no more than 0.8 kg VOC/kg solids (0.8 lb VOC/lb solids), as applied.

(4) Limit formaldehyde emissions by complying with the provisions specified in either paragraph (a)(4)(i) or (a)(4)(ii) of this section.

(i) Limit total formaldehyde (F_{total}) use in coatings and contact adhesives to no more than 400 pounds per rolling 12 month period.

(ii) Use coatings and contact adhesives only if they are low-formaldehyde coatings and adhesives, in any wood furniture manufacturing operations.

(b) [NA - NOT A NEW AFFECTED SOURCE]

(c) At all times, the owner or operator must operate and maintain any affected source, including associated air pollution control equipment and monitoring equipment, in a manner consistent with safety and good air pollution control practices for minimizing emissions. Determination of whether such operation and maintenance procedures are being used will be based on information available to the Administrator which may include, but is not limited to, monitoring results, review of operation and maintenance procedures, review of operation and maintenance records, and inspection of the source.

[60 FR 62936, Dec. 7, 1995, as amended at 76 FR 72072, Nov. 21, 2011]

§63.803 Work practice standards.

(a) Work practice implementation plan. (1) Each owner or operator of an affected source subject to this subpart shall prepare and maintain a written work practice implementation plan that defines environmentally desirable work practices for each wood furniture operation manufacturing operation and addresses each of the work practice standards presented in paragraphs (b) through (l) of this section. The plan shall be developed no more than 60 days after the compliance date.

(2) The written work practice implementation plan shall be available for inspection by the Administrator (or delegated State, local, or Tribal authority) upon request. If the Administrator (or delegated State, local, or Tribal authority) determines that the work practice implementation plan does not include sufficient mechanisms for ensuring that the work practice standards are being implemented, the Administrator (or delegated State, local, or Tribal authority) may require the affected source to modify the plan. Revisions or modifications to the plan do not require a revision of the source's Title V permit.

(3) The inspection and maintenance plan required by paragraph (c) of this section and the formulation assessment plan for finishing operations required by paragraph (l) of this section are also reviewable by the Administrator (or delegated State,

**SECTION E. Source Group Restrictions.**

local, or Tribal authority).

(b) Operator training course. Each owner or operator of an affected source shall train all new and existing personnel, including contract personnel, who are involved in finishing, gluing, cleaning, and washoff operations, use of manufacturing equipment, or implementation of the requirements of this subpart. All new personnel, those hired after the compliance date of the standard, shall be trained upon hiring. All existing personnel, those hired before the compliance date of the standard, shall be trained within six months of the compliance date of the standard. All personnel shall be given refresher training annually. The affected source shall maintain a copy of the training program with the work practice implementation plan. The training program shall include, at a minimum, the following:

- (1) A list of all current personnel by name and job description that are required to be trained;
- (2) An outline of the subjects to be covered in the initial and refresher training for each position or group of personnel;
- (3) Lesson plans for courses to be given at the initial and the annual refresher training that include, at a minimum, appropriate application techniques, appropriate cleaning and washoff procedures, appropriate equipment setup and adjustment to minimize finishing material usage and overspray, and appropriate management of cleanup wastes; and
- (4) A description of the methods to be used at the completion of initial or refresher training to demonstrate and document successful completion.

(c) Inspection and maintenance plan. Each owner or operator of an affected source shall prepare and maintain with the work practice implementation plan a written leak inspection and maintenance plan that specifies:

- (1) A minimum visual inspection frequency of once per month for all equipment used to transfer or apply coatings, adhesives, or organic HAP solvents;
- (2) An inspection schedule;
- (3) Methods for documenting the date and results of each inspection and any repairs that were made;
- (4) The timeframe between identifying the leak and making the repair, which adheres, at a minimum, to the following schedule:
 - (i) A first attempt at repair (e.g., tightening of packing glands) shall be made no later than five calendar days after the leak is detected; and
 - (ii) Final repairs shall be made within 15 calendar days after the leak is detected, unless the leaking equipment is to be replaced by a new purchase, in which case repairs shall be completed within three months.

(d) Cleaning and washoff solvent accounting system. Each owner or operator of an affected source shall develop an organic HAP solvent accounting form to record:

- (1) The quantity and type of organic HAP solvent used each month for washoff and cleaning, as defined in §63.801 of this subpart;
- (2) The number of pieces washed off, and the reason for the washoff; and
- (3) The quantity of spent organic HAP solvent generated from each washoff and cleaning operation each month, and whether it is recycled onsite or disposed offsite.

(e) Chemical composition of cleaning and washoff solvents. Each owner or operator of an affected source shall not use cleaning or washoff solvents that contain any of the pollutants listed in Table 4 to this subpart, in concentrations subject to MSDS reporting as required by OSHA.

(f) Spray booth cleaning. Each owner or operator of an affected source shall not use compounds containing more than 8.0 percent by weight of VOC for cleaning spray booth components other than conveyors, continuous coaters and their

**SECTION E. Source Group Restrictions.**

enclosures, or metal filters, or plastic filters unless the spray booth is being refurbished. If the spray booth is being refurbished, that is the spray booth coating or other protective material used to cover the booth is being replaced, the affected source shall use no more than 1.0 gallon of organic HAP solvent per booth to prepare the surface of the booth prior to applying the booth coating.

(g) Storage requirements. Each owner or operator of an affected source shall use normally closed containers for storing finishing, gluing, cleaning, and washoff materials.

(h) Application equipment requirements. Each owner or operator of an affected source shall not use conventional air spray guns except when all emissions from the finishing application station are routed to a functioning control device.

(i) Line cleaning. Each owner or operator of an affected source shall pump or drain all organic HAP solvent used for line cleaning into a normally closed container.

(j) Gun cleaning. Each owner or operator of an affected source shall collect all organic HAP solvent used to clean spray guns into a normally closed container.

(k) Washoff operations. Each owner or operator of an affected source shall control emissions from washoff operations by:

(1) Using normally closed tanks for washoff; and

(2) Minimizing dripping by tilting or rotating the part to drain as much solvent as possible.

(l) Formulation assessment plan for finishing operations. Each owner or operator of an affected source shall prepare and maintain with the work practice implementation plan a formulation assessment plan that:

(1) Identifies VHAP from the list presented in Table 5 of this subpart that are being used in finishing operations by the affected source;

(2) Establishes a baseline level of usage by the affected source, for each VHAP identified in paragraph (l)(1) of this section. The baseline usage level shall be the highest annual usage from 1994, 1995, or 1996, for each VHAP identified in paragraph (l)(1) of this section. For formaldehyde, the baseline level of usage shall be based on the amount of free formaldehyde present in the finishing material when it is applied. For styrene, the baseline level of usage shall be an estimate of unreacted styrene, which shall be calculated by multiplying the amount of styrene monomer in the finishing material, when it is applied, by a factor of 0.16. Sources using a control device to reduce emissions may adjust their usage based on the overall control efficiency of the control system, which is determined using the equation in §63.805 (d) or (e).

(3) Tracks the annual usage of each VHAP identified in (l)(1) by the affected source that is present in amounts subject to MSDS reporting as required by OSHA.

(4) If, after November 1998, the annual usage of the VHAP identified in paragraph (l)(1) exceeds its baseline level, then the owner or operator of the affected source shall provide a written notification to the permitting authority that describes the amount of the increase and explains the reasons for exceedance of the baseline level. The following explanations would relieve the owner or operator from further action, unless the affected source is not in compliance with any State regulations or requirements for that VHAP:

(i) The exceedance is no more than 15.0 percent above the baseline level;

(ii) Usage of the VHAP is below the de minimis level presented in Table 5 of this subpart for that VHAP (sources using a control device to reduce emissions may adjust their usage based on the overall control efficiency of the control system, which is determined using the procedures in §63.805 (d) or (e);

(iii) The affected source is in compliance with its State's air toxic regulations or guidelines for the VHAP; or

(iv) The source of the pollutant is a finishing material with a VOC content of no more than 1.0 kg VOC/kg solids (1.0 lb VOC/lb solids), as applied.

**SECTION E. Source Group Restrictions.**

(5) If none of the above explanations are the reason for the increase, the owner or operator shall confer with the permitting authority to discuss the reason for the increase and whether there are practical and reasonable technology-based solutions for reducing the usage. The evaluation of whether a technology is reasonable and practical shall be based on cost, quality, and marketability of the product, whether the technology is being used successfully by other wood furniture manufacturing operations, or other criteria mutually agreed upon by the permitting authority and owner or operator. If there are no practical and reasonable solutions, the facility need take no further action. If there are solutions, the owner or operator shall develop a plan to reduce usage of the pollutant to the extent feasible. The plan shall address the approach to be used to reduce emissions, a timetable for implementing the plan, and a schedule for submitting notification of progress.

(6) If, after November 1998, an affected source uses a VHAP of potential concern listed in table 6 of this subpart for which a baseline level has not been previously established, then the baseline level shall be established as the de minimis level provided in that same table for that chemical. The affected source shall track the annual usage of each VHAP of potential concern identified in this paragraph that is present in amounts subject to MSDS reporting as required by OSHA. If usage of the VHAP of potential concern exceeds the de minimis level listed in table 6 of this subpart for that chemical, then the affected source shall provide an explanation to the permitting authority that documents the reason for the exceedance of the de minimis level. If the explanation is not one of those listed in paragraphs (l)(4)(i) through (l)(4)(iv) of this section, the affected source shall follow the procedures in paragraph (l)(5) of this section.

[60 FR 62936, Dec. 7, 1995, as amended at 63 FR 71380, Dec. 28, 1998; 68 FR 37353, June 23, 2003; 76 FR 72073, Nov. 21, 2011]

§63.804 Compliance procedures and monitoring requirements.

(a) The owner or operator of an existing affected source subject to §63.802(a)(1) shall comply with those provisions using any of the methods presented in §63.804 (a)(1) through (a)(4).

(1) Calculate the average VHAP content for all finishing materials used at the facility using Equation 1, and maintain a value of E no greater than 1.0;

[SEE REGULATION FOR EQUATION]

(2) Use compliant finishing materials according to the following criteria:

(i) Demonstrate that each stain, sealer, and topcoat has a VHAP content of no more than 1.0 kg VHAP/kg solids (1.0 lb VHAP/lb solids), as applied, and each thinner contains no more than 10.0 percent VHAP by weight by maintaining certified product data sheets for each coating and thinner;

(ii) Demonstrate that each washcoat, basecoat, and enamel that is purchased pre-made, that is, it is not formulated onsite by thinning another finishing material, has a VHAP content of no more than 1.0 kg VHAP/kg solids (1.0 lb VHAP/lb solids), as applied, and each thinner contains no more than 10.0 percent VHAP by weight by maintaining certified product data sheets for each coating and thinner; and

(iii) Demonstrate that each washcoat, basecoat, and enamel that is formulated at the affected source is formulated using a finishing material containing no more than 1.0 kg VHAP/kg solids (1.0 lb VHAP/lb solids) and a thinner containing no more than 3.0 percent VHAP by weight.

(3) [NA - NO ADD-ON CONTROLS]

(4) Use any combination of an averaging approach, as described in paragraph (a)(1) of this section, compliant finishing materials, as described in paragraph (a)(2) of this section, and a control system, as described in paragraph (a)(3) of this section.

(b) The owner or operator of an affected source subject to §63.802(a)(2)(i) shall comply with the provisions by using compliant foam adhesives with a VHAP content no greater than 1.8 kg VHAP/kg solids (1.8 lb VHAP/lb solids), as applied.

(c) The owner or operator of an affected source subject to §63.802(a)(2)(ii) shall comply with those provisions by using either of the methods presented in §63.804 (c)(1) and (c)(2).

**SECTION E. Source Group Restrictions.**

- (1) Use compliant contact adhesives with a VHAP content no greater than 1.0 kg VHAP/kg solids (1.0 lb VHAP/lb solids), as applied; or
- (2) [NA - NO ADD-ON CONTROLS]
- (d) [NA - AFFECTED SOURCE IS EXISTING]
- (e) [NA - AFFECTED SOURCE IS EXISTING]
- (f) Initial compliance. [NA - INITIAL COMPLIANCE DEMONSTRATION FOR EXISTING FACILITY IS IN THE PAST]
- (g) Continuous compliance demonstrations. (1) Owners or operators of an affected source subject to the provisions of §63.802 (a)(1) or (b)(1) that comply through the procedures established in §63.804 (a)(1) or (d)(1) shall demonstrate continuous compliance by submitting the results of the averaging calculation (Equation 1) for each month within that semiannual period and submitting a compliance certification with the semiannual report required by §63.807(c).
- (i) The compliance certification shall state that the value of (E), as calculated by Equation 1, is no greater than 1.0 for existing sources or 0.8 for new sources. An affected source is in violation of the standard if E is greater than 1.0 for existing sources or 0.8 for new sources for any month. A violation of the monthly average is a separate violation of the standard for each day of operation during the month, unless the affected source can demonstrate through records that the violation of the monthly average can be attributed to a particular day or days during the period.
- (ii) The compliance certification shall be signed by a responsible official of the company that owns or operates the affected source.
- (2) Owners or operators of an affected source subject to the provisions of §63.802 (a)(1) or (b)(1) that comply through the procedures established in §63.804 (a)(2) or (d)(2) shall demonstrate continuous compliance by using compliant coatings and thinners, maintaining records that demonstrate the coatings and thinners are compliant, and submitting a compliance certification with the semiannual report required by §63.807(c).
- (i) The compliance certification shall state that compliant stains, washcoats, sealers, topcoats, basecoats, enamels, and thinners, as applicable, have been used each day in the semiannual reporting period or should otherwise identify the periods of noncompliance and the reasons for noncompliance. An affected source is in violation of the standard whenever a noncompliant coating, as demonstrated by records or by a sample of the coating, is used.
- (ii) The compliance certification shall be signed by a responsible official of the company that owns or operates the affected source.
- (3) Owners or operators of an affected source subject to the provisions of §63.802 (a)(1) or (b)(1) that are complying through the procedures established in §63.804 (a)(2) or (d)(2) and are applying coatings using continuous coaters shall demonstrate continuous compliance by following the procedures in paragraph (g)(3) (i) or (ii) of this section.
- (i) Using compliant coatings, as determined by the VHAP content of the coating in the reservoir and the VHAP content as calculated from records, using compliant thinners, and submitting a compliance certification with the semiannual report required by §63.807(c).
- (A) The compliance certification shall state that compliant coatings have been used each day in the semiannual reporting period, or should otherwise identify the days of noncompliance and the reasons for noncompliance. An affected source is in violation of the standard whenever a noncompliant coating, as determined by records or by a sample of the coating, is used. Use of a noncompliant coating is a separate violation for each day the noncompliant coating is used.
- (B) The compliance certification shall be signed by a responsible official of the company that owns or operates the affected source.
- (ii) Using compliant coatings, as determined by the VHAP content of the coating in the reservoir, using compliant thinners, maintaining a viscosity of the coating in the reservoir that is no less than the viscosity of the initial coating by monitoring the viscosity with a viscosity meter or by testing the viscosity of the initial coating and retesting the coating in the reservoir each

**SECTION E. Source Group Restrictions.**

time solvent is added, maintaining records of solvent additions, and submitting a compliance certification with the semiannual report required by §63.807(c).

(A) The compliance certification shall state that compliant coatings, as determined by the VHAP content of the coating in the reservoir, have been used each day in the semiannual reporting period. Additionally, the certification shall state that the viscosity of the coating in the reservoir has not been less than the viscosity of the initial coating, that is, the coating that is initially mixed and placed in the reservoir, for any day in the semiannual reporting period.

(B) The compliance certification shall be signed by a responsible official of the company that owns or operates the affected source.

(C) An affected source is in violation of the standard when a sample of the as-applied coating exceeds the applicable limit established in §63.804 (a)(2) or (d)(2), as determined using EPA Method 311, or the viscosity of the coating in the reservoir is less than the viscosity of the initial coating.

(4) [NA - NO ADD-ON CONTROLS]

(5) Owners or operators of an affected source subject to the provisions of §63.802 (a)(2) (i) or (ii) or (b)(2) that comply through the procedures established in §63.804 (b), (c)(1), or (e)(1), shall submit a compliance certification with the semiannual report required by §63.807(c).

(i) The compliance certification shall state that compliant contact and/or foam adhesives have been used each day in the semiannual reporting period, or should otherwise identify each day noncompliant contact and/or foam adhesives were used. Each day a noncompliant contact or foam adhesive is used is a single violation of the standard.

(ii) The compliance certification shall be signed by a responsible official of the company that owns or operates the affected source.

(6) [NA - NO ADD-ON CONTROLS]

(7) Owners or operators of an affected source subject to the provisions of §63.802 (a)(3) or (b)(3) shall submit a compliance certification with the semiannual report required by §63.807(c).

(i) The compliance certification shall state that compliant strippable spray booth coatings have been used each day in the semiannual reporting period, or should otherwise identify each day noncompliant materials were used. Each day a noncompliant strippable booth coating is used is a single violation of the standard.

(ii) The compliance certification shall be signed by a responsible official of the company that owns or operates the affected source.

(8) Owners or operators of an affected source subject to the work practice standards in §63.803 shall submit a compliance certification with the semiannual report required by §63.807(c).

(i) The compliance certification shall state that the work practice implementation plan is being followed, or should otherwise identify the provisions of the plan that have not been implemented and each day the provisions were not implemented. During any period of time that an owner or operator is required to implement the provisions of the plan, each failure to implement an obligation under the plan during any particular day is a violation.

(ii) The compliance certification shall be signed by a responsible official of the company that owns or operates the affected source.

(9) Continuous compliance requirements. You must demonstrate continuous compliance with the emissions standards and operating limits by using the performance test methods and procedures in §63.805 for each affected source.

(i) General requirements. (A) You must monitor and collect data, and provide a site specific monitoring plan as required by §§63.804, 63.806 and 63.807.

**SECTION E. Source Group Restrictions.**

(B) [NA - NO ADD-ON CONTROLS]

(C) [NA - NO ADD-ON CONTROLS]

(ii) [Reserved]

(h) The owner or operator of an existing or new affected source subject to §63.802(a)(4) or (b)(4) shall comply with those provisions by using either of the methods presented in §63.804(h)(1) and (2) if complying with §63.802(a)(4)(i) or (b)(4)(i) or by using the method presented in §63.804(h)(3) if complying with §63.802(a)(4)(ii) or (b)(4)(ii).

(1) Calculate total formaldehyde emissions from all finishing materials and contact adhesives used at the facility using Equation 5 and maintain a value of F_{total} no more than 400 pounds per rolling 12 month period.

[SEE REGULATION FOR EQUATION]

(2) [NA - NO ADD-ON CONTROLS]

(3) Demonstrate compliance by use of coatings and contact adhesives only if they are low-formaldehyde coatings and contact adhesives maintaining a certified product data sheet for each coating and contact adhesive used, as required by §63.806(b)(1), and submitting a compliance certification with the semiannual report required by §63.807(c).

(i) The compliance certification shall state that low-formaldehyde coatings and contact adhesives, as applicable, have been used each day in the semiannual reporting period or should otherwise identify the periods of noncompliance and the reasons for noncompliance. An affected source is in violation of the standard whenever a coating or contact adhesive that is not low-formaldehyde, as demonstrated by records or by a sample of the coating or contact adhesive, is used. Use of a noncompliant coating or contact adhesive is a separate violation for each day the noncompliant coating or contact adhesive is used.

(ii) The compliance certification shall be signed by a responsible official of the company that owns or operates the affected source.

[60 FR 62936, Dec. 7, 1995, as amended at 76 FR 72073, Nov. 21, 2011]

§63.805 Performance test methods. [INCORPORATED BY REFERENCE]

[60 FR 62936, Dec. 7, 1995, as amended at 76 FR 72073, Nov. 21, 2011]

§63.806 Recordkeeping requirements.

(a) The owner or operator of an affected source subject to this subpart shall fulfill all recordkeeping requirements of §63.10 of subpart A, according to the applicability criteria in §63.800(d) of this subpart.

(b) The owner or operator of an affected source subject to the emission limits in §63.802 of this subpart shall maintain records of the following:

(1) A certified product data sheet for each finishing material, thinner, contact adhesive, and strippable spray booth coating subject to the emission limits in §63.802; and

(2) The VHAP content, in kg VHAP/kg solids (lb VHAP/lb solids), as applied, of each finishing material and contact adhesive subject to the emission limits in §63.802; and

(3) The VOC content, in kg VOC/kg solids (lb VOC/lb solids), as applied, of each strippable booth coating subject to the emission limits in §63.802 (a)(3) or (b)(3).

(4) The formaldehyde content, in lb/gal, as applied, of each finishing material and contact adhesive subject to the emission limits in §63.802(a)(4) or (b)(4) and chooses to comply with the 400 lb/yr limits on formaldehyde in §63.802(a)(4) (i) or (b)(4)(i).

**SECTION E. Source Group Restrictions.**

(c) The owner or operator of an affected source following the compliance method in §63.804 (a)(1) or (d)(1) shall maintain copies of the averaging calculation for each month following the compliance date, as well as the data on the quantity of coatings and thinners used that is necessary to support the calculation of E in Equation 1.

(d) The owner or operator of an affected source following the compliance procedures of §63.804 (f)(3)(ii) and (g)(3)(ii) shall maintain the records required by §63.806(b) as well as records of the following:

- (1) Solvent and coating additions to the continuous coater reservoir;
- (2) Viscosity measurements; and
- (3) Data demonstrating that viscosity is an appropriate parameter for demonstrating compliance.

(e) The owner or operator of an affected source subject to the work practice standards in §63.803 of this subpart shall maintain onsite the work practice implementation plan and all records associated with fulfilling the requirements of that plan, including, but not limited to:

- (1) Records demonstrating that the operator training program required by §63.803(b) is in place;
- (2) Records collected in accordance with the inspection and maintenance plan required by §63.803(c);
- (3) Records associated with the cleaning solvent accounting system required by §63.803(d);
- (4) [Reserved]
- (5) Records associated with the formulation assessment plan required by §63.803(l); and
- (6) Copies of documentation such as logs developed to demonstrate that the other provisions of the work practice implementation plan are followed.

(f) [NA - NO ADD-ON CONTROLS]

(g) [NA - NO ADD-ON CONTROLS]

(h) The owner or operator of an affected source subject to the emission limits in §63.802 and following the compliance provisions of §63.804(f) (1), (2), (3), (5), (7) and (8) and §63.804(g) (1), (2), (3), (5), (7), and (8) shall maintain records of the compliance certifications submitted in accordance with §63.807(c) for each semiannual period following the compliance date.

(i) The owner or operator of an affected source shall maintain records of all other information submitted with the compliance status report required by §63.9(h) and §63.807(b) and the semiannual reports required by §63.807(c).

(j) The owner or operator of an affected source shall maintain all records in accordance with the requirements of §63.10(b)(1).

(k) The owner or operator of an affected source subject to this subpart shall maintain records of the occurrence and duration of each malfunction of operation (i.e., process equipment) or the air pollution control equipment and monitoring equipment. The owner or operator shall maintain records of actions taken during periods of malfunction to minimize emissions in accordance with §63.802(c), including corrective actions to restore malfunctioning process and air pollution control and monitoring equipment to its normal or usual manner of operation.

[60 FR 62936, Dec. 7, 1995, as amended at 76 FR 72074, Nov. 21, 2011]

§63.807 Reporting requirements.

(a) The owner or operator of an affected source subject to this subpart shall fulfill all reporting requirements of §63.7 through §63.10 of subpart A (General Provisions) according to the applicability criteria in §63.800(d) of this subpart.

**SECTION E. Source Group Restrictions.**

(b) [NA - INITIAL COMPLIANCE DEMONSTRATION FOR EXISTING FACILITY IS IN THE PAST]

(c) The owner or operator of an affected source demonstrating compliance in accordance with §63.804(g)(1), (2), (3), (5), (7), (8), (h)(1), and (h)(3) shall submit a report covering the previous 6 months of wood furniture manufacturing operations.

(1) The first report shall be submitted 30 calendar days after the end of the first 6-month period following the compliance date.

(2) Subsequent reports shall be submitted 30 calendar days after the end of each 6-month period following the first report.

(3) The semiannual reports shall include the information required by §63.804(g) (1), (2), (3), (5), (7), (8), (h)(1), and (h)(3), a statement of whether the affected source was in compliance or noncompliance, and, if the affected source was in noncompliance, the measures taken to bring the affected source into compliance. If there was a malfunction during the reporting period, the report shall also include the number, duration and a brief description for each type of malfunction which occurred during the reporting period and which caused or may have caused any applicable emission limitation to be exceeded. The report must also include a description of actions taken by an owner or operator during a malfunction of an affected source to minimize emissions in accordance with §63.802(c), including actions taken to correct a malfunction.

(4) The frequency of the reports required by paragraph (c) of this section shall not be reduced from semiannually regardless of the history of the owner's or operator's compliance status.

(d) The owner or operator of an affected source demonstrating compliance in accordance with §63.804(g)(4), (6), and (h)(2) of this subpart shall submit the excess emissions and continuous monitoring system performance report and summary report required by §63.10(e) of subpart A. The report shall include the monitored operating parameter values required by §63.804(g) (4) and (6). If the source experiences excess emissions, the report shall be submitted quarterly for at least 1 year after the excess emissions occur and until a request to reduce reporting frequency is approved, as indicated in §63.10(e)(3)(C). If no excess emissions occur, the report shall be submitted semiannually.

(e) The owner or operator of an affected source required to provide a written notification under §63.803(1)(4) shall include in the notification one or more statements that explains the reasons for the usage increase. The notification shall be submitted no later than 30 calendar days after the end of the annual period in which the usage increase occurred.

[60 FR 62936, Dec. 7, 1995, as amended at 76 FR 72074, Nov. 21, 2011]

Regulatory Changes

Individual sources within this source group that are subject to 40 CFR Part 63 Subpart JJ shall comply with all applicable requirements of the Subpart. 40 CFR 63.13(a) requires submission of copies of all requests, reports and other communications to both the DEP and the EPA. The EPA copies shall be forwarded to:

United States Environmental Protection Agency
Region III, Air and Radiation Division
Permits Branch (3AD10)
Four Penn Center
1600 John F. Kennedy Boulevard
Philadelphia, Pennsylvania 19103-2852

The Department copies shall be forwarded to the DEP SCRO Air Quality Program Manager at wiveaver@pa.gov, unless otherwise directed in writing by DEP.

In the event that the Federal Subpart that is the subject of this Source Group is revised, the permittee shall comply with the revised version of the subpart, and shall not be required to comply with any provisions in this permit designated as having the subpart as their authority, to the extent that such permit provisions would be inconsistent with the applicable provisions of the revised subpart.



SECTION E. Source Group Restrictions.

II. TESTING REQUIREMENTS.

No additional testing requirements exist except as provided in other sections of this permit including Section B (Title V General Requirements).

III. MONITORING REQUIREMENTS.

No additional monitoring requirements exist except as provided in other sections of this permit including Section B (Title V General Requirements).

IV. RECORDKEEPING REQUIREMENTS.

No additional record keeping requirements exist except as provided in other sections of this permit including Section B (Title V General Requirements).

V. REPORTING REQUIREMENTS.

No additional reporting requirements exist except as provided in other sections of this permit including Section B (Title V General Requirements).

VI. WORK PRACTICE REQUIREMENTS.

No additional work practice requirements exist except as provided in other sections of this permit including Section B (Title V General Requirements).

VII. ADDITIONAL REQUIREMENTS.

No additional requirements exist except as provided in other sections of this permit including Section B (Title V General Requirements).

***** Permit Shield in Effect. *****

**SECTION E. Source Group Restrictions.**

Group Name: GROUP 002

Group Description: Woodworking Areas

Sources included in this group

ID	Name
110	PLANT 1 WOODWORKING AREAS 1A & 1B
111	PLANT 2 WOODWORKING AREAS 2A-2F
112	PLANT 3 WOODWORKING AREAS 3A-3D/3F/3G(5A)
113	PLANT 4 WOODWORKING AREAS 4A/4D/4E
122	PLANT #7 GENERATOR (CWS4073)
221	SHAVING STORAGE BIN 1, PLANT 1

I. RESTRICTIONS.**Emission Restriction(s).**

001 [25 Pa. Code §123.13]

Processes

No person shall permit the emission into the outdoor atmosphere of particulate matter from above listed woodworking areas in a manner that the concentration of particulate matter in the effluent gas exceeds 0.04 grain per dry standard cubic foot, as per §123.13(c)(1)(i).

II. TESTING REQUIREMENTS.

No additional testing requirements exist except as provided in other sections of this permit including Section B (Title V General Requirements).

III. MONITORING REQUIREMENTS.

No additional monitoring requirements exist except as provided in other sections of this permit including Section B (Title V General Requirements).

IV. RECORDKEEPING REQUIREMENTS.

No additional record keeping requirements exist except as provided in other sections of this permit including Section B (Title V General Requirements).

V. REPORTING REQUIREMENTS.

No additional reporting requirements exist except as provided in other sections of this permit including Section B (Title V General Requirements).

VI. WORK PRACTICE REQUIREMENTS.

002 [25 Pa. Code §127.441]

Operating permit terms and conditions.

The above listed sources and the respective controls (dust collectors) shall be operated and maintained in accordance with the manufacturers specifications, or as per the respective operating handbooks.

VII. ADDITIONAL REQUIREMENTS.

No additional requirements exist except as provided in other sections of this permit including Section B (Title V General Requirements).

***** Permit Shield in Effect. *****

**SECTION E. Source Group Restrictions.**

Group Name: GROUP 003

Group Description: Comfort Heaters

Sources included in this group

ID	Name
031	AREA HEATERS

I. RESTRICTIONS.**Emission Restriction(s).****# 001 [25 Pa. Code §127.441]****Operating permit terms and conditions.**

(a) No person shall permit the use of fuels other than commercial No. 2 oil. Sulfur content of the #2 oil shall not exceed 0.0015 percent, weight basis, as per 25 Pa. Code §123.22(a)(2).

(b) The maximum allowable sulfur content beginning on September 1, 2020, expressed as parts per million (ppm) by weight or percentage by weight is as follows:

No. 2 fuel oil: 15 ppm or 0.0015%

Note: shipments of commercial fuel oil that were stored at the facility prior to the effective date of September 1, 2020, may be consumed in its entirety prior to meeting the limits as stated in paragraph (b) above.

II. TESTING REQUIREMENTS.

No additional testing requirements exist except as provided in other sections of this permit including Section B (Title V General Requirements).

III. MONITORING REQUIREMENTS.**# 002 [25 Pa. Code §127.511]****Monitoring and related recordkeeping and reporting requirements.**

(a) The permittee shall monitor sulfur content of No. 2 oil by conducting fuel analysis or as per the fuel supplier's certification, for each shipment of oil.

(b) The permittee shall monitor SO₂ emissions quarterly by using the sulfur content in fuel, as per the fuel analysis conducted by the permittee or the supplier on a quarterly basis, or on a shipment to shipment basis.

IV. RECORDKEEPING REQUIREMENTS.**# 003 [25 Pa. Code §127.511]****Monitoring and related recordkeeping and reporting requirements.**

The permittee shall maintain comprehensive and accurate record of the following:

(a) Amount of No. 2 oil consumed both on monthly and calendar year basis. The fuels consumed by the combustion sources may be grouped and reported.

(b) Sulfur content of No. 2 oil on a quarterly basis, from fuel supplier's certificate.

V. REPORTING REQUIREMENTS.

No additional reporting requirements exist except as provided in other sections of this permit including Section B (Title V General Requirements).

VI. WORK PRACTICE REQUIREMENTS.**# 004 [25 Pa. Code §127.441]****Operating permit terms and conditions.**

The above listed sources shall be operated and maintained as per the manufacturer's specifications, or the operating

**SECTION E. Source Group Restrictions.**

handbooks.

VII. ADDITIONAL REQUIREMENTS.

005 [25 Pa. Code §127.441]

Operating permit terms and conditions.

The fuel used in the area heaters is No. 2 fuel oil.

***** Permit Shield in Effect. *****

**SECTION E. Source Group Restrictions.**

Group Name: GROUP 005

Group Description: State Requirements for Wood Furniture Manufacturing

Sources included in this group

ID	Name
201	PLANT 5 SPRAY BOOTHS
202	PLANT 7 SPRAY BOOTHS
205	LAB COAT SPRAY BOOTH
206	RECIPROCATING SPRAY LINE/OVENS VENJAKOB NO. 1
207	RECIPROCATING SPRAY LINE/OVENS VENJAKOB NO. 2
208	RECIPROCATING SPRAY LINE/OVENS VENJAKOB NO. 3

I. RESTRICTIONS.**Emission Restriction(s).**

001 [25 Pa. Code §129.101]

General provisions and applicability

§ 129.101. General provisions and applicability.

(a) This section and § § 129.102—129.107 apply to each wood furniture manufacturing facility located in a county included in the northeast ozone transport region or in a county designated as severe, serious, moderate or marginal ozone nonattainment that emits or has the potential to emit 25 tons or more per year of VOCs from wood furniture manufacturing operations.

(b) [NA - SUBJECT TO (c)]

(c) An existing wood furniture manufacturing facility that increases its actual emissions or potential to emit to 25 tons per year or more of VOCs from wood furniture manufacturing operations shall comply with this section and § § 129.102—129.107 within 1 year after becoming subject to subsection (a), except for those facilities which have RACT determinations approved by the EPA as revisions to the SIP prior to June 10, 2000.

(d) At a minimum, a new source installed at an existing facility that is subject to the requirements of subsection (a) shall comply with the emission standards of § 129.102 (relating to emission standards) upon installation of the new source.

(e) The owner or operator of a wood furniture manufacturing facility subject to this section, § § 129.52 and 129.102—129.107 shall comply with the more stringent emissions limitation or applicable requirement for wood furniture manufacturing operations in § 129.52 or this section and § § 129.102—129.107.

(f) The VOC standards in § 129.102 Table IV do not apply to a coating used exclusively for determining product quality and commercial acceptance, touch-up and repair and other small quantity coatings if the coating meets the following criteria:

(1) The quantity of coating used does not exceed 50 gallons per year for a single coating and a total of 200 gallons per year for all coatings combined for the facility.

(2) The owner or operator of the facility requests, in writing, and the Department approves, in writing, the exemption prior to use of the coating.

§ 129.102. Emission standards.

An owner or operator of a facility subject to this section, § § 129.101 and 129.103—129.107 shall limit VOC emissions from wood furniture manufacturing operations by:

(1) Applying either waterborne topcoats or a combination of sealers and topcoats and strippable spray booth coatings with a VOC content equal to or less than the standards specified in Table IV:

TABLE IV REQUIREMENTS:

**SECTION E. Source Group Restrictions.**

Emission Limits of VOC for Wood Furniture Manufacturing Sealers, Topcoats and Strippable Spray Booth Coatings As Applied, in Pounds of VOC Per Pound of Coating Solids (kg VOC/kg of Coating Solids), by Category

(1) Waterborne Topcoats: 0.8

(2)(i) High solids coating systems, Sealer: 1.9

(2)(ii) High solids coating systems, Topcoat: 1.8

(3)(i)(a) Acid-cured alkyd amino systems, Acid-cured alkyd amino sealer: 2.3

(3)(i)(b) Acid-cured alkyd amino systems, Acid-cured alkyd amino conversion varnish topcoat: 2.0

(3)(ii)(a) Acid-cured alkyd amino systems, Other sealer: 1.9

(3)(ii)(b) Acid-cured alkyd amino systems, Acid-cured alkyd amino conversion varnish topcoat: 2.0

(3)(iii)(a) Acid-cured alkyd amino systems, Acid-cured alkyd amino sealer: 2.3

(3)(iii)(b) Acid-cured alkyd amino systems, Other topcoat: 1.8

(4) Waterborne strippable spray booth coating: 0.8

END OF TABLE IV REQUIREMENTS:

(2) [NA - EMISSION AVERAGING NOT USED]

(3) [NA - ADD-ON CONTROLS NOT USED]

(4) [NA - COMBO METHOD NOT USED]

§ 129.103. Work practice standards.

(a) Work practice implementation plan. Within 60 days after the compliance date specified in § 129.101(b) or (c) (relating to general provisions and applicability), an owner or operator of a facility subject to the requirements in this section and §§ 129.101, 129.102 and 129.104—129.107 shall:

(1) Prepare and maintain a written work practice implementation plan that defines work practices for each wood furniture manufacturing operation and addresses the provisions in subsections (b)—(j). The owner or operator of the facility shall comply with the work practice implementation plan.

(2) Make available the written work practice implementation plan for inspection by the Department upon request. If the Department determines that the work practice implementation plan does not adequately address the criteria specified in subsections (b)—(j), the Department may require that the facility owner or operator modify the plan.

(b) Operator training program. New and existing personnel, including contract personnel, who are involved in coating, cleaning or washoff operations or implementation of the requirements of this section, §§ 129.101, 129.102 and 129.104—129.107 shall complete an operator training program.

(1) For a facility subject to § 129.101(b), new personnel hired after June 10, 2000, shall be trained upon hiring. For a facility subject to the requirements of § 129.101(c), new personnel shall be trained upon hiring.

(2) For a facility subject to § 129.101(b), existing personnel hired before June 10, 2000, shall be trained by December 11, 2000. For a facility subject to § 129.101(c), existing personnel shall be trained at least 6 months before the compliance date.

(3) Personnel shall be given refresher training annually.

**SECTION E. Source Group Restrictions.**

(4) A copy of the written operator training program shall be maintained with the work practice implementation plan. The operator training program shall include the following:

- (i) A list of all current personnel by name and job description that are required to be trained.
- (ii) An outline of the subjects to be covered in the initial and annual refresher training sessions for each position or group of personnel.
- (iii) Lesson plans for courses to be given at the initial and annual refresher training sessions that include, at a minimum, appropriate application techniques, appropriate cleaning and washoff procedures, appropriate equipment setup and adjustment to minimize coating usage and overspray and appropriate management of cleanup wastes.
- (iv) A description of the methods to be used at the completion of the initial or annual refresher training sessions to demonstrate and document successful completion.
- (v) A record of the date each employe is trained.

(c) Leak inspection and maintenance plan. An owner or operator of a facility shall prepare and maintain with the work practice implementation plan a written leak inspection and maintenance plan which shall include the following:

- (1) A minimum visual inspection frequency of once per month for all equipment used to transfer or apply coatings or solvents.
- (2) An inspection schedule.
- (3) The methods for documenting the date and results of each inspection and any repairs that were made.
- (4) The time frame between identifying a leak and making the repair, which shall adhere to the following schedule:
 - (i) A first attempt at repairs, including tightening of packing glands, shall be made within 5 working days after the leak is detected.
 - (ii) Final repairs shall be made within 15 working days, unless the leaking equipment is to be replaced by a new purchase, in which case repairs shall be completed within 3 months.

(d) Cleaning and washoff solvent accounting system. A solvent accounting form shall be developed to account for solvents used in cleaning and washoff operations. The information recorded on the form shall include the following:

- (1) The total number of pieces processed through washoff operations each month and the reason for the washoff operations.
- (2) The name and total quantity of each solvent used each month for:
 - (i) Cleaning activities.
 - (ii) Washoff operations.
- (3) The name and total quantity of each solvent evaporated to the atmosphere each month from:
 - (i) Cleaning activities.
 - (ii) Washoff operations.

(e) Spray booth cleaning. An owner or operator of a facility may not use compounds containing more than 8.0% by weight of VOC for cleaning spray booth components other than conveyors, continuous coaters and their enclosures, or metal filters, unless the spray booth is being refurbished. If the spray booth is being refurbished, that is, the spray booth coating or other material used to cover the booth is being replaced, the facility shall use no more than 1.0 gallon of solvent to prepare the

**SECTION E. Source Group Restrictions.**

booth prior to applying the booth coating.

(f) Storage requirements. An owner or operator of a facility shall use normally closed containers for storing coating, cleaning and washoff materials.

(g) Application equipment requirements. An owner or operator of a facility may not use conventional air spray guns to apply coatings except under any of the following circumstances:

(1) To apply coatings that have a VOC content no greater than 1.0 lb VOC/lb solids (1.0 kg VOC/kg solids), as applied.

(2) For touch-up and repair coatings under one of the following circumstances:

(i) The coatings are applied after completion of the wood furniture manufacturing operation.

(ii) The coatings are applied after the stain and before any other type of coating is applied, and the coatings are applied from a container that has a volume of no more than 2.0 gallons.

(3) The spray is automated, that is, the spray gun is aimed and triggered automatically, not manually.

(4) The emissions from the surface coating process are directed to a VOC control system.

(5) The conventional air spray gun is used to apply coatings and the cumulative total usage of those coatings is no more than 5.0% of the total gallons of coating used during each semiannual reporting period.

(6) The conventional air spray gun is used to apply stain on a part for which the Department notifies the operator, in writing, of its determination that it is technically or economically infeasible to use any other spray application technology. To support the facility's claim of technical or economic infeasibility, a videotape, a technical report or other documentation shall be submitted to the Department showing either independently or in combination, the following:

(i) The production speed is too high or the part shape is too complex for one operator to coat the part, and the application station is not large enough to accommodate an additional operator.

(ii) The excessively large vertical spray area of the part makes it difficult to avoid sagging or runs in the stain.

(h) Line cleaning. The solvent used for line cleaning shall be pumped or drained into a normally closed container.

(i) Spray gun cleaning. The solvent used to clean spray guns shall be collected into a normally closed container.

(j) Washoff operations. The emissions from washoff operations shall be controlled by the following:

(1) Using normally closed containers for washoff operations.

(2) Minimizing dripping by tilting or rotating the part to drain as much solvent as possible.

§ 129.104. Compliance procedures and monitoring requirements.

(a) Compliance methods. An owner or operator of a facility subject to the emission standards in § 129.102 (relating to emission standards) shall demonstrate compliance with those provisions by using one or more of the following methods:

(1) To support that each sealer, topcoat and strippable spray booth coating meets the requirements of § 129.102(1) (relating to emission standards):

(i) Maintain CPDSs for each of the coatings.

(ii) Maintain documentation showing the VOC content of the as applied coating in lbs VOC/lb solids, if solvent or other VOC is added to the coating before application.

**SECTION E. Source Group Restrictions.**

(iii) Perform sampling and testing in accordance with the procedures and test methods in Chapter 139 (relating to sampling and testing).

(2) [NA - ADD-ON CONTROLS NOT USED]

(b) Initial compliance.

(1) Compliant coatings. An owner or operator of a facility subject to § 129.102(1) that is complying through the procedures in subsection (a)(1) shall submit an initial compliance status report as required by § 129.106(a) (relating to reporting requirements), stating that compliant sealers, topcoats and strippable spray booth coatings are being used by the facility.

(2) [NA - NO CONTINUOUS COATERS]

(3) [NA - ADD-ON CONTROLS NOT USED]

(4) Work practice implementation plan. An owner or operator of a facility subject to the work practice standards of § 129.103 (relating to work practice standards) shall submit an initial compliance status report as required by § 129.106(a), stating that the work practice implementation plan has been developed and procedures have been established for implementing the provisions of the plan.

(c) Continuous compliance demonstrations. An owner or operator of a facility subject to the requirements of this section and § § 129.101—129.103 and 129.105—129.107 shall submit, in writing, to the Department a compliance certification with the semiannual report required by § 129.106(b).

(1) Compliant coatings. An owner or operator of a facility subject to § 129.102 that is complying through the procedures specified in subsection (a)(1) shall demonstrate continuous compliance by the following:

(i) Using compliant coatings.

(ii) Maintaining records that demonstrate the coatings are compliant.

(iii) Submitting a compliance certification which states that compliant sealers, topcoats, or both, and strippable spray booth coatings have been used each day in the semiannual reporting period or should otherwise identify the days of noncompliance and the reasons for noncompliance.

(2) [NA - NO CONTINUOUS COATERS]

(3) [NA - ADD-ON CONTROLS NOT USED]

(4) Work practice implementation plan. An owner or operator of a facility subject to the work practice standards of § 129.103 shall demonstrate continuous compliance by following the work practice implementation plan and submitting a compliance certification which states that the work practice implementation plan is being followed, or should otherwise identify the periods of noncompliance with the work practice standards and the reasons for noncompliance.

(d) Compliance certification requirements. The compliance certification shall be signed by a responsible official of the company that owns or operates the facility. In addition to the certification requirements of this section, the certification shall state that, based on information and belief formed after reasonable inquiry, the statements and information in the documents are true, accurate and complete.

§ 129.105. Recordkeeping requirements.

(a) Requirement. The owner or operator of a wood furniture manufacturing operation shall keep records to demonstrate compliance with this section and § § 129.101—129.104, 129.106 and 129.107. The records shall be maintained for at least 5 years.

(b) Compliant coatings. The following records shall be maintained to demonstrate compliance with § 129.102 (relating to emission standards).

**SECTION E. Source Group Restrictions.**

- (1) A certified product data sheet for each coating and strippable spray booth coating subject to the emission limits of § 129.102.
 - (2) The VOC content as applied, lbs VOC/lb solids (kg VOC/kg solids), of each coating and strippable spray booth coating subject to the emission limits of § 129.102, and copies of data sheets documenting how the as applied values were determined.
 - (c) [NA - NO CONTINUOUS COATERS]
 - (d) [NA - ADD-ON CONTROLS NOT USED]
 - (e) Work practice implementation plan. The owner or operator of a facility subject to the work practice standards of § 129.103 (relating to work practice standards) shall maintain onsite copies of the work practice implementation plan and all records associated with fulfilling the requirements of that plan, including:
 - (1) Records demonstrating that the operator training program is in place.
 - (2) Records maintained in accordance with the leak inspection and maintenance plan.
 - (3) Records associated with the cleaning and washoff solvent accounting system.
 - (4) Records associated with the limitation on the use of conventional air spray guns showing total coating usage and the percentage of coatings applied with conventional air spray guns for each semiannual reporting period.
 - (5) Records showing the VOC content of compounds used for cleaning booth components, except for solvent used to clean conveyors, continuous coaters and their enclosures or metal filters.
 - (6) Copies of logs and other documentation developed to demonstrate that the other provisions of the work practice implementation plan are followed.
 - (f) In addition to the recordkeeping requirements of subsection (a), the owner or operator of a facility that complies with § 129.103 or § 129.104(a)(1) shall maintain a copy of the compliance certifications submitted in accordance with § 129.106(b) (relating to reporting requirements) for each semiannual period following the compliance date.
 - (g) The owner or operator of a facility shall maintain a copy of the other information submitted with the initial status report required by § 129.106(a) and the semiannual reports required by § 129.106(b).
- § 129.106. Reporting requirements.
- (a) Initial compliance report date. The initial compliance report shall be submitted to the Department within 60 days after the compliance date specified in § 129.101(b) and (c) (relating to general provisions and applicability). The report shall include the items required by § 129.104(b) (relating to compliance procedures and monitoring requirements).
 - (b) Semiannual compliance report dates. When demonstrating compliance in accordance with § 129.104(a)(1) or (2), a semiannual report covering the previous 6 months of wood furniture manufacturing operations shall be submitted to the Department according to the following schedule:
 - (1) The first report shall be submitted within 30 calendar days after the end of the first 6-month period following the compliance date specified in § 129.101(b) and (c).
 - (2) Subsequent reports shall be submitted within 30 calendar days after the end of each 6-month period following the first report.
 - (3) Each semiannual report shall include the information required by § 129.104(c) and (d), a statement of whether the facility was in compliance or noncompliance and, if the facility was in noncompliance, the measures taken to bring the facility into compliance.

**SECTION E. Source Group Restrictions.**

§ 129.107. Special provisions for facilities using an emissions averaging approach.

(a) - (g) [NA - EMISSION AVERAGING NOT USED]

002 [25 Pa. Code §129.52]**Surface coating processes**

(a) All coatings, associated with the wood furniture manufacturing operations, as applied, shall comply with the following requirements below:

- | | |
|---------------------------------|--------------------------------|
| (1) Topcoats and enamels | 3.0 lbs VOC/lb coating solids |
| (2) Washcoats | 14.3 lbs VOC/lb coating solids |
| (3) Final repair coat | 3.3 lbs VOC/lb coating solids |
| (4) Basecoats | 2.2 lbs VOC/lb coating solids |
| (5) Cosmetic specialty coatings | 14.3 lbs VOC/lb coating solids |
| (6) Sealers | 3.9 lbs VOC/lb coating solids |

(b) The VOC standards of subsection (a) above, do not apply to a coating used exclusively for determining product quality and commercial acceptance, touch-up and repair and other small quantity coatings if the coating meets the following criteria:

- (1) The quantity of coating used does not exceed 50 gallons per year for a single coating and a total of 200 gallons per year for all coatings combined for the facility.
- (2) The permittee requests in writing, and the Department approves, in writing, the exemption prior to use of the coating.

(c) The VOC content of the as applied coating, expressed in units of weight of VOC per weight of coating solids, shall be calculated as follows:

$$\text{VOC(A)} = [W(1)/W(2)]$$

Where:

VOC(A) = VOC content in lb VOC/lb of coating solids.

W(1) = Weight percent of VOC [W(3)-W(4)-W(5)]

W(2) = Weight percent of solids of the as applied coating

W(3) = Weight percent of total volatiles (100% - weight percent solids)

W(4) = Weight percent of water

W(5) = Weight percent of exempt solvents

II. TESTING REQUIREMENTS.**# 003 [25 Pa. Code §129.52]****Surface coating processes**

Sampling and testing shall be done in accordance with the procedures and test methods specified in Chapter 139.14(a)(1).

**SECTION E. Source Group Restrictions.****III. MONITORING REQUIREMENTS.**

No additional monitoring requirements exist except as provided in other sections of this permit including Section B (Title V General Requirements).

IV. RECORDKEEPING REQUIREMENTS.**# 004 [25 Pa. Code §129.52]****Surface coating processes**

(a) The permittee shall maintain records sufficient to demonstrate compliance with this permit. At a minimum, the facility shall maintain daily records of the following parameters for each coating, thinner, and other components as supplied:

- (1) The coating, thinner or component name and identification number.
- (2) The volume used.
- (3) The mix ratio.
- (4) The density or specific gravity.
- (5) The weight percent of total volatiles, water, solids and exempt solvents.
- (6) The VOC content of each coating, thinner and other component as applied.
- (7) The VOC content of each as applied coating.

(b) The records shall be maintained for a period of 5 years and be made available to the Department upon request.

V. REPORTING REQUIREMENTS.

No additional reporting requirements exist except as provided in other sections of this permit including Section B (Title V General Requirements).

VI. WORK PRACTICE REQUIREMENTS.**# 005 [25 Pa. Code §129.52]****Surface coating processes**

A person may not cause or permit the emission into the outdoor atmosphere of VOCs from the application of wood furniture coatings unless the coatings are applied using electrostatic, airless, curtain coating, roller coating, hand roller, hand brush, flow coating, dip coating, or high volume-low pressure application equipment. Air atomized sprays may be used to apply cosmetic specialty coatings if the volume of the cosmetic specialty coating is less than 5% by volume of the total coating used at the facility or to apply final repair coatings.

VII. ADDITIONAL REQUIREMENTS.**# 006 [25 Pa. Code §129.52]****Surface coating processes**

Should credits be desired for those waste coatings or solvents sent off-site for either recycling or incineration at a legally permitted facility, the following information will be required:

- (a) The quantities being disposed of;
- (b) The VOC content of the waste coatings or solvents being disposed of;
- (c) Documentation to verify the above requirements.

*** Permit Shield in Effect. ***

**SECTION E. Source Group Restrictions.**

Group Name: GROUP 006

Group Description: 40 CFR Part 60, Subpart IIII - Emergency Generators

Sources included in this group

ID	Name
114	CUSTOMER SERVICE GENERATOR (CWS3789)
115	WAREHOUSE GENERATOR (CWS3770)
122	PLANT #7 GENERATOR (CWS4073)

I. RESTRICTIONS.

No additional requirements exist except as provided in other sections of this permit including Section B (Title V General Requirements).

II. TESTING REQUIREMENTS.

No additional testing requirements exist except as provided in other sections of this permit including Section B (Title V General Requirements).

III. MONITORING REQUIREMENTS.

No additional monitoring requirements exist except as provided in other sections of this permit including Section B (Title V General Requirements).

IV. RECORDKEEPING REQUIREMENTS.

No additional record keeping requirements exist except as provided in other sections of this permit including Section B (Title V General Requirements).

V. REPORTING REQUIREMENTS.

No additional reporting requirements exist except as provided in other sections of this permit including Section B (Title V General Requirements).

VI. WORK PRACTICE REQUIREMENTS.

No additional work practice requirements exist except as provided in other sections of this permit including Section B (Title V General Requirements).

VII. ADDITIONAL REQUIREMENTS.

**# 001 [40 CFR Part 60 Standards of Performance for New Stationary Sources §40 CFR 60.4200]
Subpart IIII - Standards of Performance for Stationary Compression Ignition Internal Combustion Engines
Am I subject to this subpart?**

§ 60.4200 Am I subject to this subpart?

(a) The provisions of this subpart are applicable to manufacturers, owners, and operators of stationary compression ignition (CI) internal combustion engines (ICE) and other persons as specified in paragraphs (a)(1) through (a)(4) of this section. For the purposes of this subpart, the date that construction commences is the date the engine is ordered by the owner or operator.

(1) [NA NOT AN ENGINE MANUFACTURER]

(2) Owners and operators of stationary CI ICE that commence construction after July 11, 2005, where the stationary CI ICE are:

(i) Manufactured after April 1, 2006, and are not fire pump engines, or

(ii) [NA - NOT FIRE PUMP ENGINE]

(3) [NA - NOT MODIFIED OR RECONSTRUCTED]

**SECTION E. Source Group Restrictions.**

(4) The provisions of § 60.4208 of this subpart are applicable to all owners and operators of stationary CI ICE that commence construction after July 11, 2005.

(b) [NA – TEST CELL NOT INVOLVED]

(c) [NA - FACILITY IS A MAJOR SOURCE OF HAPS THAT CURRENTLY OPERATES UNDER A TITLE V OPERATING PERMIT]

(d) Stationary CI ICE may be eligible for exemption from the requirements of this subpart as described in 40 CFR part 1068, subpart C (or the exemptions described in 40 CFR part 89, subpart J and 40 CFR part 94, subpart J, for engines that would need to be certified to standards in those parts), except that owners and operators, as well as manufacturers, may be eligible to request an exemption for national security.

(e) [NA – NOT TEMPORARY REPLACEMENT UNIT(S)]

[71 FR 39172, July 11, 2006, as amended at 76 FR 37967, June 28, 2011]

Emission Standards for Owners and Operators

§ 60.4204 What emission standards must I meet for non-emergency engines if I am an owner or operator of a stationary CI internal combustion engine?

[NA – UNIT(S) ARE EMERGENCY]

§ 60.4205 What emission standards must I meet for emergency engines if I am an owner or operator of a stationary CI internal combustion engine?

(a) Owners and operators of pre-2007 model year emergency stationary CI ICE with a displacement of less than 10 liters per cylinder that are not fire pump engines must comply with the emission standards in Table 1 to this subpart. Owners and operators of pre-2007 model year emergency stationary CI ICE with a displacement of greater than or equal to 10 liters per cylinder and less than 30 liters per cylinder that are not fire pump engines must comply with the emission standards in 40 CFR 94.8(a)(1).

(b) Owners and operators of 2007 model year and later emergency stationary CI ICE with a displacement of less than 30 liters per cylinder that are not fire pump engines must comply with the emission standards for new nonroad CI engines in §60.4202, for all pollutants, for the same model year and maximum engine power for their 2007 model year and later emergency stationary CI ICE.

(c) [NA - ENGINES ARE NOT FIRE PUMP UNITS]

(d) [NA - ENGINE DISPLACEMENT IS LESS THAN 30 LITERS PER CYLINDER]

(e) [NA - PERFORMANCE TESTING NOT REQUIRED FOR THE ABOVE GENERATORS]

(f) [NA - GENERATORS ARE NOT MODIFIED OR RECONSTRUCTED]

[Amended at 76 FR page 37969, June 28, 2011]

§ 60.4206 How long must I meet the emission standards if I am an owner or operator of a stationary CI internal combustion engine?

Owners and operators of stationary CI ICE must operate and maintain stationary CI ICE that achieve the emission standards as required in §§ 60.4204 and 60.4205 over the entire life of the engine.

[76 FR 37969, June 28, 2011]

Fuel Requirements for Owners and Operators

**SECTION E. Source Group Restrictions.**

§ 60.4207 What fuel requirements must I meet if I am an owner or operator of a stationary CI internal combustion engine subject to this subpart?

(a)) [NA - REQUIREMENT SUPERCEDED BY PARAGRAPH(b) BELOW]

(b) Beginning October 1, 2010, owners and operators of stationary CI ICE subject to this subpart with a displacement of less than 30 liters per cylinder that use diesel fuel must use diesel fuel that meets the requirements of 40 CFR 80.510(b) for nonroad diesel fuel, except that any existing diesel fuel purchased (or otherwise obtained) prior to October 1, 2010, may be used until depleted.

[NOTE: All Nonroad, (NR) diesel fuel is subject to the following per-gallon standards:

(1) Sulfur content.

(i) 15 ppm maximum for NR diesel fuel.

(2) Cetane index or aromatic content, as follows:

(i) A minimum cetane index of 40; or

(ii) A maximum aromatic content of 35 volume percent.]

(c) [Reserved]

(d) [NA - UNITS(S) < 30 L/CYL]

(e) [NA – NO NATIONAL SECURITY EXEMPTION]

[71 FR 39172, July 11, 2006, as amended at 76 FR 37969, June 28, 2011; 78 FR 6695, Jan. 30, 2013]

Other Requirements for Owners and Operators

§ 60.4208 What is the deadline for importing or installing stationary CI ICE produced in previous model years?

(a) [NA - ABOVE ENGINES WERE INSTALLED PRIOR TO 2008]

(b) [NA - UNIT(S) > 25 HP AND/OR ARE FIRE PUMP ENGINES]

(c) - (g) [NA - UNIT(S) ARE EMERGENCY]

(h) [NA - IMPORTATION NOT RELEVANT IN THIS CASE]

(i) The requirements of this section do not apply to owners or operators of stationary CI ICE that have been modified, reconstructed, and do not apply to engines that were removed from one existing location and reinstalled at a new location.

[71 FR 39172, July 11, 2006, as amended at 76 FR 37969, June 28, 2011]

§ 60.4209 What are the monitoring requirements if I am an owner or operator of a stationary CI internal combustion engine?

If you are an owner or operator, you must meet the monitoring requirements of this section. In addition, you must also meet the monitoring requirements specified in § 60.4211.

(a) If you are an owner or operator of an emergency stationary CI internal combustion engine that does not meet the standards applicable to non-emergency engines, you must install a non-resettable hour meter prior to startup of the engine.

(b) If you are an owner or operator of a stationary CI internal combustion engine equipped with a diesel particulate filter to

**SECTION E. Source Group Restrictions.**

comply with the emission standards in §60.4204, the diesel particulate filter must be installed with a backpressure monitor that notifies the owner or operator when the high backpressure limit of the engine is approached.

[71 FR 39172, July 11, 2006, as amended at 76 FR 37969, June 28, 2011]

Compliance Requirements

§ 60.4211 What are my compliance requirements if I am an owner or operator of a stationary CI internal combustion engine?

(a) If you are an owner or operator and must comply with the emission standards specified in this subpart, you must do all of the following, except as permitted under paragraph (g) of this section:

(1) Operate and maintain the stationary CI internal combustion engine and control device according to the manufacturer's emission-related written instructions;

(2) Change only those emission-related settings that are permitted by the manufacturer; and

(3) Meet the requirements of 40 CFR parts 89, 94 and/or 1068, as they apply to you.

(b) If you are an owner or operator of a pre-2007 model year stationary CI internal combustion engine and must comply with the emission standards specified in §§60.4204(a) or 60.4205(a), or if you are an owner or operator of a CI fire pump engine that is manufactured prior to the model years in table 3 to this subpart and must comply with the emission standards specified in §60.4205(c), you must demonstrate compliance according to one of the methods specified in paragraphs (b)(1) through (5) of this section.

(b)(1) Purchasing an engine certified according to 40 CFR part 89 or 40 CFR part 94, as applicable, for the same model year and maximum engine power. The engine must be installed and configured according to the manufacturer's specifications.

(b)(2) thru (b)(5) [NA - THE GENERATORS ARE CERTIFIED]

(c) If you are an owner or operator of a 2007 model year and later stationary CI internal combustion engine and must comply with the emission standards specified in § 60.4204(b) or § 60.4205(b), or if you are an owner or operator of a CI fire pump engine that is manufactured during or after the model year that applies to your fire pump engine power rating in table 3 to this subpart and must comply with the emission standards specified in § 60.4205(c), you must comply by purchasing an engine certified to the emission standards in § 60.4204(b), or § 60.4205(b) or (c), as applicable, for the same model year and maximum (or in the case of fire pumps, NFPA nameplate) engine power. The engine must be installed and configured according to the manufacturer's emission-related specifications, except as permitted in paragraph (g) of this section.

(d) [NA - UNITS NOT SUBJECT TO § 60.4204(c) or § 60.4205(d)]

(e) [NA - NOT MODIFIED/RECONSTRUCTED]

(f) If you own or operate an emergency stationary ICE, you must operate the emergency stationary ICE according to the requirements in paragraphs (f)(1) through (3) of this section. In order for the engine to be considered an emergency stationary ICE under this subpart, any operation other than emergency operation, maintenance and testing, emergency demand response, and operation in non-emergency situations for 50 hours per year, as described in paragraphs (f)(1) through (3) of this section, is prohibited. If you do not operate the engine according to the requirements in paragraphs (f)(1) through (3) of this section, the engine will not be considered an emergency engine under this subpart and must meet all requirements for non-emergency engines.

(1) There is no time limit on the use of emergency stationary ICE in emergency situations.

(2) You may operate your emergency stationary ICE for any combination of the purposes specified in paragraphs (f)(2)(i) through (iii) of this section for a maximum of 100 hours per calendar year. Any operation for non-emergency situations as allowed by paragraph (f)(3) of this section counts as part of the 100 hours per calendar year allowed by this paragraph (f)(2).

**SECTION E. Source Group Restrictions.**

(i) Emergency stationary ICE may be operated for maintenance checks and readiness testing, provided that the tests are recommended by federal, state or local government, the manufacturer, the vendor, the regional transmission organization or equivalent balancing authority and transmission operator, or the insurance company associated with the engine. The owner or operator may petition the Administrator for approval of additional hours to be used for maintenance checks and readiness testing, but a petition is not required if the owner or operator maintains records indicating that federal, state, or local standards require maintenance and testing of emergency ICE beyond 100 hours per calendar year.

(ii) [VACATED PER COURT ORDER AS OF 5/2/16]

(iii) [VACATED PER COURT ORDER AS OF 5/2/16]

(3) Emergency stationary ICE may be operated for up to 50 hours per calendar year in non-emergency situations. The 50 hours of operation in non-emergency situations are counted as part of the 100 hours per calendar year for maintenance and testing and emergency demand response provided in paragraph (f)(2) of this section. Except as provided in paragraph (f)(3)(i) of this section, the 50 hours per calendar year for non-emergency situations cannot be used for peak shaving or non-emergency demand response, or to generate income for a facility to an electric grid or otherwise supply power as part of a financial arrangement with another entity.

(i) The 50 hours per year for non-emergency situations can be used to supply power as part of a financial arrangement with another entity if all of the following conditions are met:

(A) The engine is dispatched by the local balancing authority or local transmission and distribution system operator;

(B) The dispatch is intended to mitigate local transmission and/or distribution limitations so as to avert potential voltage collapse or line overloads that could lead to the interruption of power supply in a local area or region.

(C) The dispatch follows reliability, emergency operation or similar protocols that follow specific NERC, regional, state, public utility commission or local standards or guidelines.

(D) The power is provided only to the facility itself or to support the local transmission and distribution system.

(E) The owner or operator identifies and records the entity that dispatches the engine and the specific NERC, regional, state, public utility commission or local standards or guidelines that are being followed for dispatching the engine. The local balancing authority or local transmission and distribution system operator may keep these records on behalf of the engine owner or operator.

(ii) [Reserved]

(g) If you do not install, configure, operate, and maintain your engine and control device according to the manufacturer's emission-related written instructions, or you change emission-related settings in a way that is not permitted by the manufacturer, you must demonstrate compliance as follows:

(1) [NA – UNIT(S) > 100 HP]

(2) If you are an owner or operator of a stationary CI internal combustion engine greater than or equal to 100 HP and less than or equal to 500 HP, you must keep a maintenance plan and records of conducted maintenance and must, to the extent practicable, maintain and operate the engine in a manner consistent with good air pollution control practice for minimizing emissions. In addition, you must conduct an initial performance test to demonstrate compliance with the applicable emission standards within 1 year of startup, or within 1 year after an engine and control device is no longer installed, configured, operated, and maintained in accordance with the manufacturer's emission-related written instructions, or within 1 year after you change emission-related settings in a way that is not permitted by the manufacturer.

(3) [NA - GENERATORS ARE LESS THAN 500 HP]

(h) The requirements for operators and prohibited acts specified in 40 CFR 1039.665 apply to owners or operators of stationary CI ICE equipped with AECDS for qualified emergency situations as allowed by 40 CFR 1039.665.

**SECTION E. Source Group Restrictions.**

[71 FR 39172, July 11, 2006, as amended at 76 FR 37970, June 28, 2011; 78 FR 6695, Jan. 30, 2013; 81 FR 44219, July 7, 2016]

Testing Requirements for Owners and Operators

§ 60.4212 What test methods and other procedures must I use if I am an owner or operator of a stationary CI internal combustion engine with a displacement of less than 30 liters per cylinder?

[NA – TESTING NOT REQUIRED FOR CERTIFIED UNITS WHICH ARE NOT ALTERED PER 60.4211(g)]

[71 FR 39172, July 11, 2006, as amended at 76 FR 37971, June 28, 2011]

§ 60.4213 What test methods and other procedures must I use if I am an owner or operator of a stationary CI internal combustion engine with a displacement of greater than or equal to 30 liters per cylinder?

[NA – DISPLACEMENT <30 L/CYL]

[71 FR 39172, July 11, 2006, as amended at 76 FR 37971, June 28, 2011]

Notification, Reports, and Records for Owners and Operators

§ 60.4214 What are my notification, reporting, and recordkeeping requirements if I am an owner or operator of a stationary CI internal combustion engine?

(a) [NA – UNIT(S) ARE EMERGENCY]

(b) If the stationary CI internal combustion engine is an emergency stationary internal combustion engine, the owner or operator is not required to submit an initial notification. Starting with the model years in table 5 to this subpart, if the emergency engine does not meet the standards applicable to non-emergency engines in the applicable model year, the owner or operator must keep records of the operation of the engine in emergency and non-emergency service that are recorded through the non-resettable hour meter. The owner must record the time of operation of the engine and the reason the engine was in operation during that time.

(c) [NA - GENERATORS DO NOT MAKE USE OF PARTICULATE FILTRATION]

(d) If you own or operate an emergency stationary CI ICE with a maximum engine power more than 100 HP that operates or is contractually obligated to be available for more than 15 hours per calendar year for the purposes specified in §60.4211(f)(2)(ii) and (iii) or that operates for the purposes specified in §60.4211(f)(3)(i), you must submit an annual report according to the requirements in paragraphs (d)(1) through (3) of this section.

(1) The report must contain the following information:

(i) Company name and address where the engine is located.

(ii) Date of the report and beginning and ending dates of the reporting period.

(iii) Engine site rating and model year.

(iv) Latitude and longitude of the engine in decimal degrees reported to the fifth decimal place.

(v) Hours operated for the purposes specified in §60.4211(f)(2)(ii) and (iii), including the date, start time, and end time for engine operation for the purposes specified in §60.4211(f)(2)(ii) and (iii).

(vi) Number of hours the engine is contractually obligated to be available for the purposes specified in §60.4211(f)(2)(ii) and (iii).

(vii) Hours spent for operation for the purposes specified in §60.4211(f)(3)(i), including the date, start time, and end time for

**SECTION E. Source Group Restrictions.**

engine operation for the purposes specified in §60.4211(f)(3)(i). The report must also identify the entity that dispatched the engine and the situation that necessitated the dispatch of the engine.

(2) The first annual report must cover the calendar year 2015 and must be submitted no later than March 31, 2016. Subsequent annual reports for each calendar year must be submitted no later than March 31 of the following calendar year.

(3) The annual report must be submitted electronically using the subpart specific reporting form in the Compliance and Emissions Data Reporting Interface (CEDRI) that is accessed through EPA's Central Data Exchange (CDX) (www.epa.gov/cdx). However, if the reporting form specific to this subpart is not available in CEDRI at the time that the report is due, the written report must be submitted to the Administrator at the appropriate address listed in §60.4.

(e) Owners or operators of stationary CI ICE equipped with AECDs pursuant to the requirements of 40 CFR 1039.665 must report the use of AECDs as required by 40 CFR 1039.665(e).

[71 FR 39172, July 11, 2006, as amended at 78 FR 6696, Jan. 30, 2013; 81 FR 44219, July 7, 2016]

General Provisions

§ 60.4218 What parts of the General Provisions apply to me?

Table 8 to this subpart shows which parts of the General Provisions in §§ 60.1 through 60.19 apply to you.

Reporting Addresses & Regulatory Changes

Individual sources within this source group that are subject to 40 CFR Part 60 Subpart IIII shall comply with all applicable requirements of the Subpart. 40 CFR 60.4 requires submission of copies of all requests, reports and other communications to both the Department and the EPA. The EPA copies shall be forwarded to:

United States Environmental Protection Agency
Region III, Air and Radiation Division
Permits Branch (3AD10)
Four Penn Center
1600 John F. Kennedy Boulevard
Philadelphia, Pennsylvania 19103-2852

The Department copies shall be forwarded to the DEP SCRO Air Quality Program Manager at wiveaver@pa.gov, unless otherwise directed in writing by DEP.

In the event that the Federal Subpart that is the subject of this Source Group is revised, the permittee shall comply with the revised version of the subpart, and shall not be required to comply with any provisions in this permit designated as having the subpart as their authority, to the extent that such permit provisions would be inconsistent with the applicable provisions of the revised subpart.

***** Permit Shield in Effect. *****

**SECTION E. Source Group Restrictions.**

Group Name: GROUP 007

Group Description: 40 CFR Part 63, Subpart ZZZZ - Emergency Generators

Sources included in this group

ID	Name
116	PLANT 1 & 2 EMERGENCY GENERATOR (CWS3423)
121	FIRE PUMP ENGINE (CWS251)

I. RESTRICTIONS.

No additional requirements exist except as provided in other sections of this permit including Section B (Title V General Requirements).

II. TESTING REQUIREMENTS.

No additional testing requirements exist except as provided in other sections of this permit including Section B (Title V General Requirements).

III. MONITORING REQUIREMENTS.

No additional monitoring requirements exist except as provided in other sections of this permit including Section B (Title V General Requirements).

IV. RECORDKEEPING REQUIREMENTS.

No additional record keeping requirements exist except as provided in other sections of this permit including Section B (Title V General Requirements).

V. REPORTING REQUIREMENTS.

No additional reporting requirements exist except as provided in other sections of this permit including Section B (Title V General Requirements).

VI. WORK PRACTICE REQUIREMENTS.

No additional work practice requirements exist except as provided in other sections of this permit including Section B (Title V General Requirements).

VII. ADDITIONAL REQUIREMENTS.**# 001 [40 CFR Part 63 NESHAPS for Source Categories §40 CFR 63.6585]****Subpart ZZZZ - National Emissions Standards for Hazardous Air Pollutants for Stationary Reciprocating Internal Combustion Engines****Am I subject to this subpart?**

Individual sources within this source group that are subject to 40 CFR Part 63 Subpart ZZZZ -National Emissions Standards for Hazardous Air Pollutants for Stationary Reciprocating Internal Combustion Engines shall comply with all applicable requirements of the Subpart. 40 CFR 63.13(a) requires submission of copies of all requests, reports and other communications to both the DEP and the EPA. The EPA copies shall be forwarded to:

United States Environmental Protection Agency
Region III, Air and Radiation Division
Permits Branch (3AD10)
Four Penn Center
1600 John F. Kennedy Boulevard
Philadelphia, Pennsylvania 19103-2852

The Department copies shall be forwarded to the DEP SCRO Air Quality Program Manager at wiveaver@pa.gov, unless otherwise directed in writing by DEP.

In the event that the Federal Subpart that is the subject of this Source Group is revised, the permittee shall comply with the revised version of the subpart, and shall not be required to comply with any provisions in this permit designated as having

**SECTION E. Source Group Restrictions.**

the subpart as their authority, to the extent that such permit provisions would be inconsistent with the applicable provisions of the revised subpart.

002 [40 CFR Part 63 NESHAPS for Source Categories §40 CFR 63.6585]**Subpart ZZZZ - National Emissions Standards for Hazardous Air Pollutants for Stationary Reciprocating Internal Combustion Engines****Am I subject to this subpart?**

§ 63.6585 Am I subject to this subpart?

You are subject to this subpart if you own or operate a stationary RICE at a major or area source of HAP emissions, except if the stationary RICE is being tested at a stationary RICE test cell/stand.

(a) A stationary RICE is any internal combustion engine which uses reciprocating motion to convert heat energy into mechanical work and which is not mobile. Stationary RICE differ from mobile RICE in that a stationary RICE is not a non-road engine as defined at 40 CFR 1068.30, and is not used to propel a motor vehicle or a vehicle used solely for competition.

(b) A major source of HAP emissions is a plant site that emits or has the potential to emit any single HAP at a rate of 10 tons (9.07 megagrams) or more per year or any combination of HAP at a rate of 25 tons (22.68 megagrams) or more per year, except that for oil and gas production facilities, a major source of HAP emissions is determined for each surface site.

(c) [NA – FACILITY IS MAJOR FOR HAP]

(d) NA – FACILITY IS MAJOR FOR HAP AND OPERATES UNDER A TITLE V OPERATING PERMIT]

(e) [NA – NATIONAL SECURITY EXEMPTION DOES NOT APPLY]

(f) [NA – NOT RESIDENTIAL/COMMERCIAL/INSTITUTIONAL]

[69 FR 33506, June 15, 2004, as amended at 73 FR 3603, Jan. 18, 2008; 78 FR 6700, Jan. 30, 2013]

§ 63.6590 What parts of my plant does this subpart cover?

This subpart applies to each affected source.

(a) Affected source. An affected source is any existing, new, or reconstructed stationary RICE located at a major or area source of HAP emissions, excluding stationary RICE being tested at a stationary RICE test cell/stand.

(1) Existing stationary RICE.

(i) [NA – ENGINE(S) <500 HP]

(ii) For stationary RICE with a site rating of less than or equal to 500 brake HP located at a major source of HAP emissions, a stationary RICE is existing if you commenced construction or reconstruction of the stationary RICE before June 12, 2006.

(iii) [NA – FACILITY IS MAJOR FOR HAP]

(iv) A change in ownership of an existing stationary RICE does not make that stationary RICE a new or reconstructed stationary RICE.

(2) [NA – ENGINE(S) ARE EXISTING]

(3) [NA – ENGINE(S) ARE EXISTING]

(b) Stationary RICE subject to limited requirements. (1) [NA – ENGINE(S) ARE EXISTING]

(2) [NA – ENGINE(S) ARE EXISTING]

**SECTION E. Source Group Restrictions.**

(3) The following stationary RICE do not have to meet the requirements of this subpart and of subpart A of this part, including initial notification requirements:

- (i) [NA – ENGINE(S) <500 HP]
- (ii) [NA – ENGINE(S) <500 HP]
- (iii) [NA – ENGINE(S) <500 HP]
- (iv) [NA – ENGINE(S) <500 HP]
- (v) [NA – ENGINE(S) <500 HP]
- (c) [NA – ENGINE(S) ARE EXISTING]

[69 FR 33506, June 15, 2004, as amended at 73 FR 3604, Jan. 18, 2008; 75 FR 9674, Mar. 3, 2010; 75 FR 37733, June 30, 2010; 75 FR 51588, Aug. 20, 2010; 78 FR 6700, Jan. 30, 2013]

§ 63.6595 When do I have to comply with this subpart?

(a) Affected sources. (1) If you have an existing stationary RICE, excluding existing non-emergency CI stationary RICE, with a site rating of more than 500 brake HP located at a major source of HAP emissions, you must comply with the applicable emission limitations, operating limitations and other requirements no later than June 15, 2007. If you have an existing non-emergency CI stationary RICE with a site rating of more than 500 brake HP located at a major source of HAP emissions, AN EXISTING STATIONARY CI RICE WITH A SITE RATING OF LESS THAN OR EQUAL TO 500 BRAKE HP LOCATED AT A MAJOR SOURCE OF HAP EMISSIONS, or an existing stationary CI RICE located at an area source of HAP emissions, you must comply with the applicable emission limitations, operating limitations, and other requirements no later than May 3, 2013. IF YOU HAVE AN EXISTING STATIONARY SI RICE WITH A SITE RATING OF LESS THAN OR EQUAL TO 500 BRAKE HP LOCATED AT A MAJOR SOURCE OF HAP EMISSIONS, or an existing stationary SI RICE located at an area source of HAP emissions, you must comply with the applicable emission limitations, operating limitations, and other requirements no later than October 19, 2013.

- (2) [NA – ENGINE(S) ARE EXISTING]
- (3) [NA – ENGINE(S) ARE EXISTING]
- (4) [NA – ENGINE(S) ARE EXISTING]
- (5) [NA – ENGINE(S) ARE EXISTING]
- (6) [NA – ENGINE(S) ARE EXISTING]
- (7) [NA – ENGINE(S) ARE EXISTING]
- (b) [NA – FACILITY IS MAJOR FOR HAP]

(c) If you own or operate an affected source, you must meet the applicable notification requirements in § 63.6645 and in 40 CFR part 63, subpart A.

[69 FR 33506, June 15, 2004, as amended at 73 FR 3604, Jan. 18, 2008; 75 FR 9675, Mar. 3, 2010; 75 FR 51589, Aug. 20, 2010; 78 FR 6701, Jan. 30, 2013]

Emission and Operating Limitations

§ 63.6600 What emission limitations and operating limitations must I meet if I own or operate a stationary RICE with a site rating of more than 500 brake HP located at a major source of HAP emissions?

**SECTION E. Source Group Restrictions.**

[NA – ENGINE(S) <500 HP]

§ 63.6601 What emission limitations must I meet if I own or operate a new or reconstructed 4SLB stationary RICE with a site rating of greater than or equal to 250 brake HP and less than or equal to 500 brake HP located at a major source of HAP emissions?

[NA – ENGINE(S) ARE EXISTING]

§ 63.6602 What emission limitations and other requirements must I meet if I own or operate an existing stationary RICE with a site rating of equal to or less than 500 brake HP located at a major source of HAP emissions?

If you own or operate an existing stationary RICE with a site rating of equal to or less than 500 brake HP located at a major source of HAP emissions, you must comply with the emission limitations and other requirements in Table 2c to this subpart which apply to you. Compliance with the numerical emission limitations established in this subpart is based on the results of testing the average of three 1-hour runs using the testing requirements and procedures in § 63.6620 and Table 4 to this subpart.

TABLE 2c REQUIREMENTS: Item 1

For each Emergency stationary CI RICE*, you must meet the following requirement, except during periods of startup:

- a. Change oil and filter every 500 hours of operation or annually, whichever comes first.**
- b. Inspect air cleaner every 1,000 hours of operation or annually, whichever comes first, and replace as necessary;
- c. Inspect all hoses and belts every 500 hours of operation or annually, whichever comes first, and replace as necessary.***

TABLE 2c REQUIREMENTS: Item 6

For each Emergency stationary SI RICE*, you must meet the following requirement, except during periods of startup:

- a. Change oil and filter every 500 hours of operation or annually, whichever comes first.**
- b. Inspect spark plugs every 1,000 hours of operation or annually, whichever comes first, and replace as necessary;
- c. Inspect all hoses and belts every 500 hours of operation or annually, whichever comes first, and replace as necessary.***

During periods of startup you must minimize the engine's time spent at idle and minimize the engine's startup time at startup to a period needed for appropriate and safe loading of the engine, not to exceed 30 minutes, after which time the non-startup emission limitations apply.***

* If an emergency engine is operating during an emergency and it is not possible to shut down the engine in order to perform the work practice requirements on the schedule required in Table 2c of this subpart, or if performing the work practice on the required schedule would otherwise pose an unacceptable risk under federal, state, or local law, the work practice can be delayed until the emergency is over or the unacceptable risk under federal, state, or local law has abated. The work practice should be performed as soon as practicable after the emergency has ended or the unacceptable risk under federal, state, or local law has abated. Sources must report any failure to perform the work practice on the schedule required and the federal, state or local law under which the risk was deemed unacceptable.

** Sources have the option to utilize an oil analysis program as described in § 63.6625(i) or (j) in order to extend the specified oil change requirement in Table 2c of this subpart.

*** Sources can petition the Administrator pursuant to the requirements of 40 CFR 63.6(g) for alternative work practices.

[78 FR 6701, Jan. 30, 2013]

§ 63.6603 What emission limitations, operating limitations, and other requirements must I meet if I own or operate an existing stationary RICE located at an area source of HAP emissions?

**SECTION E. Source Group Restrictions.**

[NA – FACILITY IS MAJOR FOR HAP]

§ 63.6604 What fuel requirements must I meet if I own or operate a stationary CI RICE?

(a) [NA – ENGINE(S) ARE EMERGENCY]

(b) Beginning January 1, 2015, if you own or operate an existing emergency CI stationary RICE with a site rating of more than 100 brake HP and a displacement of less than 30 liters per cylinder that uses diesel fuel and operates or is contractually obligated to be available for more than 15 hours per calendar year for the purposes specified in § 63.6640(f)(2)(ii) and (iii) or that operates for the purpose specified in § 63.6640(f)(4)(ii), you must use diesel fuel that meets the requirements in 40 CFR 80.510(b) for nonroad diesel fuel, except that any existing diesel fuel purchased (or otherwise obtained) prior to January 1, 2015, may be used until depleted.

(c) [NA – ENGINE(S) ARE EXISTING]

(d) [NA – ENGINE(S) NOT IN SPECIFIED GEOGRAPHICAL AREAS]

[78 FR 6702, Jan. 30, 2013]

General Compliance Requirements

§ 63.6605 What are my general requirements for complying with this subpart?

(a) You must be in compliance with the emission limitations, operating limitations, and other requirements in this subpart that apply to you at all times.

(b) At all times you must operate and maintain any affected source, including associated air pollution control equipment and monitoring equipment, in a manner consistent with safety and good air pollution control practices for minimizing emissions. The general duty to minimize emissions does not require you to make any further efforts to reduce emissions if levels required by this standard have been achieved. Determination of whether such operation and maintenance procedures are being used will be based on information available to the Administrator which may include, but is not limited to, monitoring results, review of operation and maintenance procedures, review of operation and maintenance records, and inspection of the source.

[75 FR 9675, Mar. 3, 2010, as amended at 78 FR 6702, Jan. 30, 2013]

Testing and Initial Compliance Requirements

§ 63.6610 By what date must I conduct the initial performance tests or other initial compliance demonstrations if I own or operate a stationary RICE with a site rating of more than 500 brake HP located at a major source of HAP emissions?

[NA – ENGINE(S) <500 HP]

§ 63.6611 By what date must I conduct the initial performance tests or other initial compliance demonstrations if I own or operate a new or reconstructed 4SLB SI stationary RICE with a site rating of greater than or equal to 250 and less than or equal to 500 brake HP located at a major source of HAP emissions?

[NA – ENGINE(S) ARE EXISTING]

§ 63.6612 By what date must I conduct the initial performance tests or other initial compliance demonstrations if I own or operate an existing stationary RICE with a site rating of less than or equal to 500 brake HP located at a major source of HAP emissions or an existing stationary RICE located at an area source of HAP emissions?

If you own or operate an existing stationary RICE with a site rating of less than or equal to 500 brake HP located at a major source of HAP emissions or an existing stationary RICE located at an area source of HAP emissions you are subject to the requirements of this section.

**SECTION E. Source Group Restrictions.**

(a) You must conduct any initial performance test or other initial compliance demonstration according to Tables 4 and 5 to this subpart that apply to you within 180 days after the compliance date that is specified for your stationary RICE in § 63.6595 and according to the provisions in § 63.7(a)(2). [PER TABLES 4 AND 5, NO TESTING APPLIES TO EMERGENCY ENGINES]

(b) [PER TABLES 4 AND 5, NO TESTING APPLIES TO EMERGENCY ENGINES]

[75 FR 9676, Mar. 3, 2010, as amended at 75 FR 51589, Aug. 20, 2010]

§ 63.6615 When must I conduct subsequent performance tests?

If you must comply with the emission limitations and operating limitations, you must conduct subsequent performance tests as specified in Table 3 of this subpart. [PER TABLE 3, NO TESTING APPLIES TO EMERGENCY ENGINES]

§ 63.6620 What performance tests and other procedures must I use?

[PER TABLES 3 AND 4, NO TESTING APPLIES TO EMERGENCY ENGINES]

§ 63.6625 What are my monitoring, installation, collection, operation, and maintenance requirements?

(a) [NA – NO CEMS REQUIRED OR ELECTED]

(b) [NA – NO CPMS REQUIRED OR ELECTED]

(c) [NA – LFG NOT USED]

(d) [NA – ENGINE(S) ARE EXISTING]

(e) If you own or operate any of the following stationary RICE, you must operate and maintain the stationary RICE and after-treatment control device (if any) according to the manufacturer's emission-related written instructions or develop your own maintenance plan which must provide to the extent practicable for the maintenance and operation of the engine in a manner consistent with good air pollution control practice for minimizing emissions:

(1) An existing stationary RICE with a site rating of less than 100 HP located at a major source of HAP emissions;

(2) An existing emergency or black start stationary RICE with a site rating of less than or equal to 500 HP located at a major source of HAP emissions;

(3) [NA – FACILITY IS MAJOR FOR HAP]

(4) [NA – FACILITY IS MAJOR FOR HAP]

(5) [NA – FACILITY IS MAJOR FOR HAP]

(6) [NA – FACILITY IS MAJOR FOR HAP]

(7) [NA – FACILITY IS MAJOR FOR HAP]

(8) [NA – FACILITY IS MAJOR FOR HAP]

(9) [NA – FACILITY IS MAJOR FOR HAP]

(10) [NA – FACILITY IS MAJOR FOR HAP]

(f) If you own or operate an existing emergency stationary RICE with a site rating of less than or equal to 500 brake HP located at a major source of HAP emissions or an existing emergency stationary RICE located at an area source of HAP emissions, you must install a non-resettable hour meter if one is not already installed.

**SECTION E. Source Group Restrictions.**

(g) [NA – ENGINE(S) ARE EMERGENCY]

(h) If you operate a new, reconstructed, or existing stationary engine, you must minimize the engine's time spent at idle during startup and minimize the engine's startup time to a period needed for appropriate and safe loading of the engine, not to exceed 30 minutes, after which time the emission standards applicable to all times other than startup in Tables 1a, 2a, 2c, and 2d to this subpart apply. [NOTE: ONLY TABLE 2c APPLIES]

(i) If you own or operate a stationary CI engine that is subject to the work, operation or management practices in items 1 or 2 of Table 2c to this subpart or in items 1 or 4 of Table 2d to this subpart, you have the option of utilizing an oil analysis program in order to extend the specified oil change requirement in Tables 2c and 2d to this subpart. The oil analysis must be performed at the same frequency specified for changing the oil in Table 2c or 2d to this subpart. The analysis program must at a minimum analyze the following three parameters: Total Base Number, viscosity, and percent water content. The condemning limits for these parameters are as follows: Total Base Number is less than 30 percent of the Total Base Number of the oil when new; viscosity of the oil has changed by more than 20 percent from the viscosity of the oil when new; or percent water content (by volume) is greater than 0.5. If all of these condemning limits are not exceeded, the engine owner or operator is not required to change the oil. If any of the limits are exceeded, the engine owner or operator must change the oil within 2 business days of receiving the results of the analysis; if the engine is not in operation when the results of the analysis are received, the engine owner or operator must change the oil within 2 business days or before commencing operation, whichever is later. The owner or operator must keep records of the parameters that are analyzed as part of the program, the results of the analysis, and the oil changes for the engine. The analysis program must be part of the maintenance plan for the engine.

(j) If you own or operate a stationary SI engine that is subject to the work, operation or management practices in items 6, 7, or 8 of Table 2c to this subpart or in items 5, 6, 7, 9, or 11 of Table 2d to this subpart, you have the option of utilizing an oil analysis program in order to extend the specified oil change requirement in Tables 2c and 2d to this subpart. The oil analysis must be performed at the same frequency specified for changing the oil in Table 2c or 2d to this subpart. The analysis program must at a minimum analyze the following three parameters: Total Acid Number, viscosity, and percent water content. The condemning limits for these parameters are as follows: Total Acid Number increases by more than 3.0 milligrams of potassium hydroxide (KOH) per gram from Total Acid Number of the oil when new; viscosity of the oil has changed by more than 20 percent from the viscosity of the oil when new; or percent water content (by volume) is greater than 0.5. If all of these condemning limits are not exceeded, the engine owner or operator is not required to change the oil. If any of the limits are exceeded, the engine owner or operator must change the oil within 2 business days of receiving the results of the analysis; if the engine is not in operation when the results of the analysis are received, the engine owner or operator must change the oil within 2 business days or before commencing operation, whichever is later. The owner or operator must keep records of the parameters that are analyzed as part of the program, the results of the analysis, and the oil changes for the engine. The analysis program must be part of the maintenance plan for the engine.

[69 FR 33506, June 15, 2004, as amended at 73 FR 3606, Jan. 18, 2008; 75 FR 9676, Mar. 3, 2010; 75 FR 51589, Aug. 20, 2010; 76 FR 12866, Mar. 9, 2011; 78 FR 6703, Jan. 30, 2013]

§ 63.6630 How do I demonstrate initial compliance with the emission limitations, operating limitations, and other requirements?

(a) [PER TABLE 5, NO TESTING APPLIES TO EMERGENCY ENGINES]

(b) [PER TABLE 5, NO TESTING APPLIES TO EMERGENCY ENGINES]

(c) You must submit the Notification of Compliance Status containing the results of the initial compliance demonstration according to the requirements in § 63.6645.

(d) [NA – ENGINE(S) ARE EMERGENCY]

(e) [NA – ENGINE(S) ARE EMERGENCY]

[69 FR 33506, June 15, 2004, as amended at 78 FR 6704, Jan. 30, 2013]

Continuous Compliance Requirements

**SECTION E. Source Group Restrictions.**

§ 63.6635 How do I monitor and collect data to demonstrate continuous compliance?

[NA – NO EMISSION OR OPERATING LIMITATIONS]

§ 63.6640 How do I demonstrate continuous compliance with the emission limitations, operating limitations, and other requirements?

(a) You must demonstrate continuous compliance with each emission limitation, operating limitation, and other requirements in Tables 1a and 1b, Tables 2a and 2b, Table 2c, and Table 2d to this subpart that apply to you [NOTE: ONLY TABLE 2c APPLIES] according to methods specified in Table 6 to this subpart.

TABLE 6 REQUIREMENTS: Item 9

For each existing emergency and black start stationary RICE ≤ 500 HP located at a major source of HAP, complying with the requirement to "Work or Management practices", you must demonstrate continuous compliance by:

- i. Operating and maintaining the stationary RICE according to the manufacturer's emission-related operation and maintenance instructions; or
- ii. Develop and follow your own maintenance plan which must provide to the extent practicable for the maintenance and operation of the engine in a manner consistent with good air pollution control practice for minimizing emissions.

END OF TABLE 6 REQUIREMENTS

(b) [NA – NO EMISSION OR OPERATING LIMITATIONS]

(c) [NA – FACILITY IS MAJOR FOR HAP]

(d) [NA – ENGINE(S) ARE EXISTING]

(e) You must also report each instance in which you did not meet the requirements in Table 8 to this subpart that apply to you. If you own or operate a new or reconstructed stationary RICE with a site rating of less than or equal to 500 brake HP located at a major source of HAP emissions (except new or reconstructed 4SLB engines greater than or equal to 250 and less than or equal to 500 brake HP), a new or reconstructed stationary RICE located at an area source of HAP emissions, or any of the following RICE with a site rating of more than 500 brake HP located at a major source of HAP emissions, you do not need to comply with the requirements in Table 8 to this subpart: An existing 2SLB stationary RICE, an existing 4SLB stationary RICE, an existing emergency stationary RICE, an existing limited use stationary RICE, or an existing stationary RICE which fires landfill gas or digester gas equivalent to 10 percent or more of the gross heat input on an annual basis. If you own or operate any of the following RICE with a site rating of more than 500 brake HP located at a major source of HAP emissions, you do not need to comply with the requirements in Table 8 to this subpart, except for the initial notification requirements: a new or reconstructed stationary RICE that combusts landfill gas or digester gas equivalent to 10 percent or more of the gross heat input on an annual basis, a new or reconstructed emergency stationary RICE, or a new or reconstructed limited use stationary RICE.

(f) If you own or operate an emergency stationary RICE, you must operate the emergency stationary RICE according to the requirements in paragraphs (f)(1) through (4) of this section. In order for the engine to be considered an emergency stationary RICE under this subpart, any operation other than emergency operation, maintenance and testing, emergency demand response, and operation in non-emergency situations for 50 hours per year, as described in paragraphs (f)(1) through (4) of this section, is prohibited. If you do not operate the engine according to the requirements in paragraphs (f)(1) through (4) of this section, the engine will not be considered an emergency engine under this subpart and must meet all requirements for non-emergency engines.

(1) There is no time limit on the use of emergency stationary RICE in emergency situations.

(2) You may operate your emergency stationary RICE for any combination of the purposes specified in paragraphs (f)(2)(i) through (iii) of this section for a maximum of 100 hours per calendar year. Any operation for non-emergency situations as allowed by paragraphs (f)(3) and (4) of this section counts as part of the 100 hours per calendar year allowed by this

**SECTION E. Source Group Restrictions.**

paragraph (f)(2).

(i) Emergency stationary RICE may be operated for maintenance checks and readiness testing, provided that the tests are recommended by federal, state or local government, the manufacturer, the vendor, the regional transmission organization or equivalent balancing authority and transmission operator, or the insurance company associated with the engine. The owner or operator may petition the Administrator for approval of additional hours to be used for maintenance checks and readiness testing, but a petition is not required if the owner or operator maintains records indicating that federal, state, or local standards require maintenance and testing of emergency RICE beyond 100 hours per calendar year.

(ii) [VACATED PER COURT ORDER AS OF 5/2/16]

(iii) [VACATED PER COURT ORDER AS OF 5/2/16]

(3) Emergency stationary RICE located at major sources of HAP may be operated for up to 50 hours per calendar year in non-emergency situations. The 50 hours of operation in non-emergency situations are counted as part of the 100 hours per calendar year for maintenance and testing and emergency demand response provided in paragraph (f)(2) of this section. The 50 hours per year for non-emergency situations cannot be used for peak shaving or non-emergency demand response, or to generate income for a facility to supply power to an electric grid or otherwise supply power as part of a financial arrangement with another entity.

(4) [NA - FACILITY IS A MAJOR SOURCE]

[69 FR 33506, June 15, 2004, as amended at 71 FR 20467, Apr. 20, 2006; 73 FR 3606, Jan. 18, 2008; 75 FR 9676, Mar. 3, 2010; 75 FR 51591, Aug. 20, 2010; 78 FR 6704, Jan. 30, 2013]

Notifications, Reports, and Records

§ 63.6645 What notifications must I submit and when?

(a) You must submit all of the notifications in §§ 63.7(b) and (c), 63.8(e), (f)(4) and (f)(6), 63.9(b) through (e), and (g) and (h) that apply to you by the dates specified if you own or operate any of the following;

(1) An existing stationary RICE with a site rating of less than or equal to 500 brake HP located at a major source of HAP emissions.

(2) [NA – FACILITY IS MAJOR FOR HAP]

(3) [NA – ENGINE(S) <500 HP]

(4) [NA – ENGINE(S) ARE EXISTING]

(5) THIS REQUIREMENT DOES NOT APPLY IF YOU OWN OR OPERATE an existing stationary RICE less than 100 HP, AN EXISTING STATIONARY EMERGENCY RICE, or an existing stationary RICE that is not subject to any numerical emission standards.

(b) [NA – PER (a)(5)]

(c) [NA – PER (a)(5)]

(d) [NA – PER (a)(5)]

(e) [NA – PER (a)(5)]

(f) [NA – PER (a)(5)]

(g) [NA – NO TESTING REQUIRED]

**SECTION E. Source Group Restrictions.**

(h) [NA – NO TESTING REQUIRED]

(i) [NA – FACILITY IS MAJOR FOR HAP]

[73 FR 3606, Jan. 18, 2008, as amended at 75 FR 9677, Mar. 3, 2010; 75 FR 51591, Aug. 20, 2010; 78 FR 6705, Jan. 30, 2013]

§ 63.6650 What reports must I submit and when?

(a) You must submit each report in Table 7 of this subpart that applies to you.

TABLE 7 REQUIREMENTS: Item 4

For each emergency stationary RICE that operate or are contractually obligated to be available for more than 15 hours per year for the purposes specified in § 63.6640(f)(2)(ii) and (iii) or that operate for the purposes specified in § 63.6640(f)(4)(ii), you must submit a Report. The report must contain the information in § 63.6650(h)(1). You must submit the report annually according to the requirements in § 63.6650(h)(2)-(3).

END OF TABLE 7 REQUIREMENTS

(b) Unless the Administrator has approved a different schedule for submission of reports under § 63.10(a), you must submit each report by the date in Table 7 of this subpart and according to the requirements in paragraphs (b)(1) through (b)(9) of this section.

(1) [NA – REQUIRED REPORT IS ANNUAL]

(2) [NA – REQUIRED REPORT IS ANNUAL]

(3) [NA – REQUIRED REPORT IS ANNUAL]

(4) [NA – REQUIRED REPORT IS ANNUAL]

(5) [NA – REQUIRED REPORT IS ANNUAL]

(6) For annual Compliance reports, the first Compliance report must cover the period beginning on the compliance date that is specified for your affected source in § 63.6595 and ending on December 31.

(7) For annual Compliance reports, the first Compliance report must be postmarked or delivered no later than January 31 following the end of the first calendar year after the compliance date that is specified for your affected source in § 63.6595.

(8) For annual Compliance reports, each subsequent Compliance report must cover the annual reporting period from January 1 through December 31.

(9) For annual Compliance reports, each subsequent Compliance report must be postmarked or delivered no later than January 31.

(c) The Compliance report must contain the information in paragraphs (c)(1) through (6) of this section.

(1) Company name and address.

(2) Statement by a responsible official, with that official's name, title, and signature, certifying the accuracy of the content of the report.

(3) Date of report and beginning and ending dates of the reporting period.

(4) [NA – NO EMISSION OR OPERATING LIMITATIONS]

**SECTION E. Source Group Restrictions.**

(5) [NA – NO EMISSION OR OPERATING LIMITATIONS]

(6) [NA – NO EMISSION OR OPERATING LIMITATIONS]

(d) [NA – NO EMISSION OR OPERATING LIMITATIONS]

(e) [NA – NO EMISSION OR OPERATING LIMITATIONS]

(f) [NA – NO EMISSION OR OPERATING LIMITATIONS]

(g) [NA – ENGINE(S) ARE EXISTING]

(h) If you own or operate an emergency stationary RICE with a site rating of more than 100 brake HP that operates or is contractually obligated to be available for more than 15 hours per calendar year for the purposes specified in § 63.6640(f)(2)(ii) and (iii) or that operates for the purpose specified in § 63.6640(f)(4)(ii), you must submit an annual report according to the requirements in paragraphs (h)(1) through (3) of this section.

(1) The report must contain the following information:

(i) Company name and address where the engine is located.

(ii) Date of the report and beginning and ending dates of the reporting period.

(iii) Engine site rating and model year.

(iv) Latitude and longitude of the engine in decimal degrees reported to the fifth decimal place.

(v) Hours operated for the purposes specified in § 63.6640(f)(2)(ii) and (iii), including the date, start time, and end time for engine operation for the purposes specified in § 63.6640(f)(2)(ii) and (iii).

(vi) Number of hours the engine is contractually obligated to be available for the purposes specified in § 63.6640(f)(2)(ii) and (iii).

(vii) Hours spent for operation for the purpose specified in § 63.6640(f)(4)(ii), including the date, start time, and end time for engine operation for the purposes specified in § 63.6640(f)(4)(ii). The report must also identify the entity that dispatched the engine and the situation that necessitated the dispatch of the engine.

(viii) If there were no deviations from the fuel requirements in § 63.6604 that apply to the engine (if any), a statement that there were no deviations from the fuel requirements during the reporting period.

(ix) If there were deviations from the fuel requirements in § 63.6604 that apply to the engine (if any), information on the number, duration, and cause of deviations, and the corrective action taken.

(2) The first annual report must cover the calendar year 2015 and must be submitted no later than March 31, 2016. Subsequent annual reports for each calendar year must be submitted no later than March 31 of the following calendar year.

(3) The annual report must be submitted electronically using the subpart specific reporting form in the Compliance and Emissions Data Reporting Interface (CEDRI) that is accessed through EPA's Central Data Exchange (CDX) (www.epa.gov/cdx). However, if the reporting form specific to this subpart is not available in CEDRI at the time that the report is due, the written report must be submitted to the Administrator at the appropriate address listed in § 63.13.

[69 FR 33506, June 15, 2004, as amended at 75 FR 9677, Mar. 3, 2010; 78 FR 6705, Jan. 30, 2013]

§ 63.6655 What records must I keep?

(a) If you must comply with the emission and operating limitations, you must keep the records described in paragraphs (a)(1) through (a)(5), (b)(1) through (b)(3) and (c) of this section.

**SECTION E. Source Group Restrictions.**

(1) A copy of each notification and report that you submitted to comply with this subpart, including all documentation supporting any Initial Notification or Notification of Compliance Status that you submitted, according to the requirement in § 63.10(b)(2)(xiv).

(2) Records of the occurrence and duration of each malfunction of operation (i.e., process equipment) or the air pollution control and monitoring equipment.

(3) [NA – NO TESTING REQUIRED]

(4) [NA – NO EMISSION OR OPERATING LIMITATIONS]

(5) Records of actions taken during periods of malfunction to minimize emissions in accordance with § 63.6605(b), including corrective actions to restore malfunctioning process and air pollution control and monitoring equipment to its normal or usual manner of operation.

(b) [NA – NO EMISSION OR OPERATING LIMITATIONS]

(c) [NA – ENGINE(S) ARE EXISTING]

(d) You must keep the records required in Table 6 of this subpart to show continuous compliance with each emission or operating limitation that applies to you.

(e) You must keep records of the maintenance conducted on the stationary RICE in order to demonstrate that you operated and maintained the stationary RICE and after-treatment control device (if any) according to your own maintenance plan if you own or operate any of the following stationary RICE;

(1) An existing stationary RICE with a site rating of less than 100 brake HP located at a major source of HAP emissions.

(2) An existing stationary emergency RICE.

(3) [NA – FACILITY IS MAJOR FOR HAP]

(f) If you own or operate any of the stationary RICE in paragraphs (f)(1) through (2) of this section, you must keep records of the hours of operation of the engine that is recorded through the non-resettable hour meter. The owner or operator must document how many hours are spent for emergency operation, including what classified the operation as emergency and how many hours are spent for non-emergency operation. If the engine is used for the purposes specified in § 63.6640(f)(2)(ii) or (iii) or § 63.6640(f)(4)(ii), the owner or operator must keep records of the notification of the emergency situation, and the date, start time, and end time of engine operation for these purposes.

(1) An existing emergency stationary RICE with a site rating of less than or equal to 500 brake HP located at a major source of HAP emissions that does not meet the standards applicable to non-emergency engines.

(2) [NA – FACILITY IS MAJOR FOR HAP]

[69 FR 33506, June 15, 2004, as amended at 75 FR 9678, Mar. 3, 2010; 75 FR 51592, Aug. 20, 2010; 78 FR 6706, Jan. 30, 2013]

§ 63.6660 In what form and how long must I keep my records?

(a) Your records must be in a form suitable and readily available for expeditious review according to § 63.10(b)(1).

(b) As specified in § 63.10(b)(1), you must keep each record for 5 years following the date of each occurrence, measurement, maintenance, corrective action, report, or record.

(c) You must keep each record readily accessible in hard copy or electronic form for at least 5 years after the date of each occurrence, measurement, maintenance, corrective action, report, or record, according to § 63.10(b)(1).

**SECTION E. Source Group Restrictions.**

[69 FR 33506, June 15, 2004, as amended at 75 FR 9678, Mar. 3, 2010]

Other Requirements and Information

§ 63.6665 What parts of the General Provisions apply to me?

Table 8 to this subpart shows which parts of the General Provisions in §§ 63.1 through 63.15 apply to you. If you own or operate a new or reconstructed stationary RICE with a site rating of less than or equal to 500 brake HP located at a major source of HAP emissions (except new or reconstructed 4SLB engines greater than or equal to 250 and less than or equal to 500 brake HP), a new or reconstructed stationary RICE located at an area source of HAP emissions, or any of the following RICE with a site rating of more than 500 brake HP located at a major source of HAP emissions, you do not need to comply with any of the requirements of the General Provisions specified in Table 8: An existing 2SLB stationary RICE, an existing 4SLB stationary RICE, an existing stationary RICE that combusts landfill or digester gas equivalent to 10 percent or more of the gross heat input on an annual basis, an existing emergency stationary RICE, or an existing limited use stationary RICE. If you own or operate any of the following RICE with a site rating of more than 500 brake HP located at a major source of HAP emissions, you do not need to comply with the requirements in the General Provisions specified in Table 8 except for the initial notification requirements: A new stationary RICE that combusts landfill gas or digester gas equivalent to 10 percent or more of the gross heat input on an annual basis, a new emergency stationary RICE, or a new limited use stationary RICE.

[75 FR 9678, Mar. 3, 2010]

*** **Permit Shield in Effect.** ***

**SECTION E. Source Group Restrictions.**

Group Name: GROUP 008

Group Description: 40 CFR part 60, Subpart JJJJ - Emergency Generators

Sources included in this group

ID	Name
123	NOC GENERATOR (CWS4547)

I. RESTRICTIONS.

No additional requirements exist except as provided in other sections of this permit including Section B (Title V General Requirements).

II. TESTING REQUIREMENTS.

No additional testing requirements exist except as provided in other sections of this permit including Section B (Title V General Requirements).

III. MONITORING REQUIREMENTS.

No additional monitoring requirements exist except as provided in other sections of this permit including Section B (Title V General Requirements).

IV. RECORDKEEPING REQUIREMENTS.

No additional record keeping requirements exist except as provided in other sections of this permit including Section B (Title V General Requirements).

V. REPORTING REQUIREMENTS.

No additional reporting requirements exist except as provided in other sections of this permit including Section B (Title V General Requirements).

VI. WORK PRACTICE REQUIREMENTS.

No additional work practice requirements exist except as provided in other sections of this permit including Section B (Title V General Requirements).

VII. ADDITIONAL REQUIREMENTS.

**# 001 [40 CFR Part 60 Standards of Performance for New Stationary Sources §40 CFR 60.4230]
Subpart JJJJ - Standards of Performance for Stationary Spark Ignition Internal Combustion Engines
Am I subject to this subpart?**

§ 60.4230 Am I subject to this subpart?

(a) The provisions of this subpart are applicable to manufacturers, owners, and operators of stationary spark ignition (SI) internal combustion engines (ICE) as specified in paragraphs (a)(1) through (6) of this section. For the purposes of this subpart, the date that construction commences is the date the engine is ordered by the owner or operator.

(1) [NA - UNIT(S) >19 KW]

(2) [NA - UNITS DO NOT USE GASOLINE OR RICH BURN LPG]

(3) [NA - NOT AN ENGINE MANUFACTURER]

(4) Owners and operators of stationary SI ICE that commence construction after June 12, 2006, where the stationary SI ICE are manufactured:

(i) [NA - UNIT(S) < 500 HP]

(ii) [NA - UNIT(S) < 500 HP]

**SECTION E. Source Group Restrictions.**

(iii) on or after July 1, 2008, for engines with a maximum engine power less than 500 HP; or

(iv) on or after January 1, 2009, for emergency engines with a maximum engine power greater than 19 KW (25 HP).

(5) [NA - UNIT(S) NOT MODIFIED OR RECONSTRUCTED]

(6) The provisions of § 60.4236 of this subpart are applicable to all owners and operators of stationary SI ICE that commence construction after June 12, 2006.

(b) [NA - ENGINE TEST CELL NOT RELEVANT HERE]

(c) If you are an owner or operator of an area source subject to this subpart, you are exempt from the obligation to obtain a permit under 40 CFR part 70 or 40 CFR part 71, provided you are not required to obtain a permit under 40 CFR 70.3(a) or 40 CFR 71.3(a) for a reason other than your status as an area source under this subpart. Notwithstanding the previous sentence, you must continue to comply with the provisions of this subpart as applicable.

(d) [NA - UNIT(S) DO NOT USE ALCOHOL-BASED FUELS]

(e) [NA - NO NATIONAL SECURITY EXEMPTION]

(f) [NA - NOT TEMPORARY REPLACEMENT UNIT(S)]

[73 FR 3591, Jan. 18, 2008, as amended at 76 FR 37972, June 28, 2011]

Emission Standards for Owners and Operators

§ 60.4233 What emission standards must I meet if I am an owner or operator of a stationary SI internal combustion engine?

(a) [NA - UNIT(S) >19 KW/25 HP]

(b) [NA - UNIT(S) DO NOT BURN GASOLINE]

(c) [NA - UNIT(S) ARE NOT RICH BURN LPG]

(d) [NA - UNIT(S) IS > 100HP]

TABLE 1 REQUIREMENTS:

Maximum engine power: > or = 130HP

Manufacture date: 8/10/2017

NOx limit: 2.0 g/hp-hr

CO limit: 4.0 g/hp-hr

VOC limit: 1.0 g/hp-hr

* For purposes of this subpart, when calculating emissions of volatile organic compounds, emissions of formaldehyde should not be included.

END OF TABLE 1 REQUIREMENTS

(e) Owners and operators of stationary SI ICE with a maximum engine power greater than or equal to 75 KW (100 HP) (except gasoline and rich burn engines that use LPG) must comply with the emission standards in Table 1 to this subpart for their stationary SI ICE. For owners and operators of stationary SI ICE with a maximum engine power greater than or equal to 100 HP (except gasoline and rich burn engines that use LPG) manufactured prior to January 1, 2011 that were certified to the certification emission standards in 40 CFR part 1048 applicable to engines that are not severe duty engines, if such stationary SI ICE was certified to a carbon monoxide (CO) standard above the standard in Table 1 to this subpart,

**SECTION E. Source Group Restrictions.**

then the owners and operators may meet the CO certification (not field testing) standard for which the engine was certified.

(f) [NA - UNIT(S) NOT MODIFIED OR RECONSTRUCTED]

(g) [NA - STATIONARY WELLHEAD GAS NOT USED]

(h) [NA – EMERGENCY ENGINES NOT REQUIRED TO MEET 40 CFR 1048.101]

[73 FR 3591, Jan. 18, 2008, as amended at 76 FR 37973, June 28, 2011]

§ 60.4234 How long must I meet the emission standards if I am an owner or operator of a stationary SI internal combustion engine?

Owners and operators of stationary SI ICE must operate and maintain stationary SI ICE that achieve the emission standards as required in § 60.4233 over the entire life of the engine.

Other Requirements for Owners and Operators

§ 60.4235 What fuel requirements must I meet if I am an owner or operator of a stationary SI gasoline fired internal combustion engine subject to this subpart?

[NA - UNIT(S) DO NOT USE GASOLINE]

§ 60.4236 What is the deadline for importing or installing stationary SI ICE produced in previous model years?

(a) After July 1, 2010, owners and operators may not install stationary SI ICE with a maximum engine power of less than 500 HP that do not meet the applicable requirements in § 60.4233.

(b) [NA - UNIT(S) < 500 HP]

(c) For emergency stationary SI ICE with a maximum engine power of greater than 19 KW (25 HP), owners and operators may not install engines that do not meet the applicable requirements in § 60.4233 after January 1, 2011.

(d) [NA - IMPORTATION NOT RELEVANT IN THIS CASE]

(e) The requirements of this section do not apply to owners and operators of stationary SI ICE that have been modified or reconstructed, and they do not apply to engines that were removed from one existing location and reinstalled at a new location.

§ 60.4237 What are the monitoring requirements if I am an owner or operator of an emergency stationary SI internal combustion engine?

(a) [NA - UNIT(S) < 500 HP]

(b) Starting on January 1, 2011, if the emergency stationary SI internal combustion engine that is greater than or equal to 130 HP and less than 500 HP that was built on or after January 1, 2011, does not meet the standards applicable to non-emergency engines, the owner or operator must install a non-resettable hour meter.

(c) [NA - UNIT(S) IS > 130HP].

Compliance Requirements for Owners and Operators

§ 60.4243 What are my compliance requirements if I am an owner or operator of a stationary SI internal combustion engine?

(a) [NA - UNIT(S) NOT SUBJECT TO § 60.4233(a) through (c); NEVERTHELESS, THIS SECTION IS REFERENCED FROM (b)]

**SECTION E. Source Group Restrictions.**

If you are an owner or operator of a stationary SI internal combustion engine that is manufactured after July 1, 2008, and must comply with the emission standards specified in § 60.4233(a) through (c), you must comply by purchasing an engine certified to the emission standards in § 60.4231(a) through (c), as applicable, for the same engine class and maximum engine power. In addition, you must meet one of the requirements specified in (a)(1) and (2) of this section.

(1) If you operate and maintain the certified stationary SI internal combustion engine and control device according to the manufacturer's emission-related written instructions, you must keep records of conducted maintenance to demonstrate compliance, but no performance testing is required if you are an owner or operator. You must also meet the requirements as specified in 40 CFR part 1068, subparts A through D, as they apply to you. If you adjust engine settings according to and consistent with the manufacturer's instructions, your stationary SI internal combustion engine will not be considered out of compliance.

(2) If you do not operate and maintain the certified stationary SI internal combustion engine and control device according to the manufacturer's emission-related written instructions, your engine will be considered a non-certified engine, and you must demonstrate compliance according to (a)(2)(i) through (iii) of this section, as appropriate.

(i) [NA - UNIT(S) >100 HP]

(ii) If you are an owner or operator of a stationary SI internal combustion engine greater than or equal to 100 HP and less than or equal to 500 HP, you must keep a maintenance plan and records of conducted maintenance and must, to the extent practicable, maintain and operate the engine in a manner consistent with good air pollution control practice for minimizing emissions. In addition, you must conduct an initial performance test within 1 year of engine startup to demonstrate compliance.

(iii) [NA - UNIT(S) <500 HP]

(b) If you are an owner or operator of a stationary SI internal combustion engine and must comply with the emission standards specified in § 60.4233(d) or (e), you must demonstrate compliance according to one of the methods specified in paragraphs (b)(1) and (2) of this section.

(1) Purchasing an engine certified according to procedures specified in this subpart, for the same model year and demonstrating compliance according to one of the methods specified in paragraph (a) of this section.

(2) [NA - UNIT(S) ARE CERTIFIED]

(c) [NA - UNIT(S) NOT MODIFIED OR RECONSTRUCTED]

(d) If you own or operate an emergency stationary ICE, you must operate the emergency stationary ICE according to the requirements in paragraphs (d)(1) through (3) of this section. In order for the engine to be considered an emergency stationary ICE under this subpart, any operation other than emergency operation, maintenance and testing, emergency demand response, and operation in non-emergency situations for 50 hours per year, as described in paragraphs (d)(1) through (3) of this section, is prohibited. If you do not operate the engine according to the requirements in paragraphs (d)(1) through (3) of this section, the engine will not be considered an emergency engine under this subpart and must meet all requirements for non-emergency engines.

(1) There is no time limit on the use of emergency stationary ICE in emergency situations.

(2) You may operate your emergency stationary ICE for any combination of the purposes specified in paragraphs (d)(2)(i) through (iii) of this section for a maximum of 100 hours per calendar year. Any operation for non-emergency situations as allowed by paragraph (d)(3) of this section counts as part of the 100 hours per calendar year allowed by this paragraph (d)(2).

(i) Emergency stationary ICE may be operated for maintenance checks and readiness testing, provided that the tests are recommended by federal, state or local government, the manufacturer, the vendor, the regional transmission organization or equivalent balancing authority and transmission operator, or the insurance company associated with the engine. The owner or operator may petition the Administrator for approval of additional hours to be used for maintenance checks and readiness testing, but a petition is not required if the owner or operator maintains records indicating that federal, state, or

**SECTION E. Source Group Restrictions.**

local standards require maintenance and testing of emergency ICE beyond 100 hours per calendar year.

(ii)-(iii) [VACATED BY COURT ORDER]

(3) [NA – NOT USED TO SUPPLY POWER AS PART OF A FINANCIAL ARRANGEMENT]

(e) Owners and operators of stationary SI natural gas fired engines may operate their engines using propane for a maximum of 100 hours per year as an alternative fuel solely during emergency operations, but must keep records of such use. If propane is used for more than 100 hours per year in an engine that is not certified to the emission standards when using propane, the owners and operators are required to conduct a performance test to demonstrate compliance with the emission standards of § 60.4233.

(f) If you are an owner or operator of a stationary SI internal combustion engine that is less than or equal to 500 HP and you purchase a non-certified engine or you do not operate and maintain your certified stationary SI internal combustion engine and control device according to the manufacturer's written emission-related instructions, you are required to perform initial performance testing as indicated in this section, but you are not required to conduct subsequent performance testing unless the stationary engine is rebuilt or undergoes major repair or maintenance. A rebuilt stationary SI ICE means an engine that has been rebuilt as that term is defined in 40 CFR 94.11(a).

(g) [NA - CATALYSTS NOT USED]

(h) [NA- UNIT(S) <500 HP]

(i) [NA - UNIT(S) NOT MODIFIED OR RECONSTRUCTED]

[73 FR 3591, Jan. 18, 2008, as amended at 76 FR 37974, June 28, 2011; 78 FR 6697, Jan. 30, 2013]

Testing Requirements for Owners and Operators

§ 60.4244 What test methods and other procedures must I use if I am an owner or operator of a stationary SI internal combustion engine?

[NA – TESTING NOT REQUIRED FOR CERTIFIED UNITS WHICH ARE NOT ALTERED PER 60.4243(f)]

Notification, Reports, and Records for Owners and Operators

§ 60.4245 What are my notification, reporting, and recordkeeping requirements if I am an owner or operator of a stationary SI internal combustion engine?

Owners or operators of stationary SI ICE must meet the following notification, reporting and recordkeeping requirements.

(a) Owners and operators of all stationary SI ICE must keep records of the information in paragraphs (a)(1) through (4) of this section.

(1) All notifications submitted to comply with this subpart and all documentation supporting any notification.

(2) Maintenance conducted on the engine.

(3) If the stationary SI internal combustion engine is a certified engine, documentation from the manufacturer that the engine is certified to meet the emission standards and information as required in 40 CFR parts 90, 1048, 1054, and 1060, as applicable.

(4) If the stationary SI internal combustion engine is not a certified engine or is a certified engine operating in a non-certified manner and subject to § 60.4243(a)(2), documentation that the engine meets the emission standards.

(b) For all stationary SI emergency ICE greater than or equal to 500 HP manufactured on or after July 1, 2010, that do not meet the standards applicable to non-emergency engines, the owner or operator of must keep records of the hours of

**SECTION E. Source Group Restrictions.**

operation of the engine that is recorded through the non-resettable hour meter. For all stationary SI emergency ICE greater than or equal to 130 HP and less than 500 HP manufactured on or after July 1, 2011 that do not meet the standards applicable to non-emergency engines, the owner or operator of must keep records of the hours of operation of the engine that is recorded through the non-resettable hour meter. For all stationary SI emergency ICE greater than 25 HP and less than 130 HP manufactured on or after July 1, 2008, that do not meet the standards applicable to non-emergency engines, the owner or operator of must keep records of the hours of operation of the engine that is recorded through the non-resettable hour meter. The owner or operator must document how many hours are spent for emergency operation, including what classified the operation as emergency and how many hours are spent for non-emergency operation.

(c) [NA - UNIT(S) <500 HP]

(d) [NA – TESTING NOT REQUIRED FOR CERTIFIED UNITS WHICH ARE NOT ALTERED PER 60.4243(f)]

(e) [NA – NOT OPERATED FOR DEMAND RESPONSE OR VOLTAGE DEVIATION, OR TO SUPPLY POWER AS PART OF A FINANCIAL ARRANGEMENT]

[73 FR 3591, Jan. 18, 2008, as amended at 73 FR 59177, Oct. 8, 2008; 78 FR 6697, Jan. 30, 2013; 81 FR 59809, Aug. 30, 2016]

General Provisions

§ 60.4246 What parts of the General Provisions apply to me?

Table 3 to this subpart shows which parts of the General Provisions in §§ 60.1 through 60.19 apply to you.

Reporting Addresses & Regulatory Changes

Individual sources within this source group that are subject to 40 CFR Part 60 Subpart JJJJ shall comply with all applicable requirements of the Subpart. 40 CFR Part 60.4 requires submission of copies of all requests, reports and other communications to both the DEP and the EPA. The EPA copies shall be forwarded to:

United States Environmental Protection Agency
Region III, Air and Radiation Division
Permits Branch (3AD10)
Four Penn Center
1600 John F. Kennedy Boulevard
Philadelphia, Pennsylvania 19103-2852

The Department copies shall be forwarded to the DEP SCRO Air Quality Program Manager at wiveaver@pa.gov, unless otherwise directed in writing by DEP.

In the event that the Federal Subpart that is the subject of this Source Group is revised, the permittee shall comply with the revised version of the subpart, and shall not be required to comply with any provisions in this permit designated as having the subpart as their authority, to the extent that such permit provisions would be inconsistent with the applicable provisions of the revised subpart.

***** Permit Shield in Effect. *****

**SECTION F. Alternative Operation Requirements.**

No Alternative Operations exist for this Title V facility.

**SECTION G. Emission Restriction Summary.**

No emission restrictions listed in this section of the permit.

**SECTION H. Miscellaneous.**

This permit amendment includes those requirements from plan approval No. 36-05017G, issued on November 17, 2020, and operating permit No. 36-05017, renewed on March 22, 2021 and supercedes those requirements.

The following sources and operations do not require any work practice standards or testing, monitoring, recordkeeping and reporting requirement:

Source ID #036 - Pump House Boiler - 1.0 mmBtu/hr

Source ID #042 - Truck Garage Waste Oil Boiler - 0.499mmBtu/hr

Source ID #610A Fuel Oil Storage Tank #1, capacity 10,000 gallons of #2 Oil, underground, containing volatile organic compounds (VOC) with vapor pressure of 1.5 psia (10.5 kilopascals) or less, as per 25 Pa. Code Section 129.57.

Source ID #610B - Fuel Oil Storage Tank #2, capacity 10,000 gallons of diesel, underground, containing VOC with vapor pressure of 1.5 psia (10.5 kilopascals) or less, as per 25 Pa. Code Section 129.57.

The cleaning, sanding and panel cleaner air knife, with particulate matter control with existing fabric filter 4-E, ID C106E.

Old truck garage waste oil heater rated at 0.14mmBtu/hr.

Duraguard booth in finishing lab area.

Source ID #201 - Plant 5 Spray Booths includes the following components:

201A
201B
201C
201D
201E
201F
201G
201H
201I
201J

Source ID #202 - Plant 7 Spray Booths consists of the following components:

202A
202B
202C
202D
202E
202X

Source ID #035, Air Makeup Units 1 thru 8, consists of the following equipment:

Rupp model RAM230 (HV1) - 7.096 mmbtu/hr

Rupp model RAM230 (HV2) - 7.096 mmbtu/hr

Rupp model RAM36 (HV3) - 4.989 mmbtu/hr

Rupp model RAM36 (HV4) - 4.12 mmbtu/hr

Rupp model RAM36 (HV5) - 4.12 mmtu/hr

Greenheck model IG-115 (MAU1) - 0.40 mmbtu/hr

Cambridge model M112 (3740) (MAU7) - 0.454 mmbtu/hr

Cambridge model M110 (3741) (MAU6)- 0.454 mmbtu/hr

Source ID #206 thru #208 - Venjakob Reciprocating Spray Lines/Ovens No. 1, No. 2 & No. 3 - each consists of the following components:

Timed belt conveyor/feed system
Fork cross transfer unit
Belt conveyor
Panel cleaner

**SECTION H. Miscellaneous.**

Infrared preheating

8 nozzle reciprocating spray machine

Flash-off zone

Vertical dryer

HVIR tunnel

Belt conveyor

Cooling tunnel

Belt conveyor



***** End of Report *****
